

CS 55231

Internet Engineering 

Kent State University
Dept. of Computer Science

LECT-4B

Digital Trunk Lines

Digital Telephone

- Long before computer communication came into being, telephone companies developed digital communication technology.
- Telephone industries have devised complex long distance digital communication technology.
- Most computer communication rides on the digital communication lines provided by the telephone carriers.
- Key Difference: Synchronous Communication:
 - system designed to move data at a precise rate.

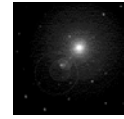

INTERNET
ENGINEERING

LECT-4b, S-3
IN2007B, javed@kent.edu
Javed I. Khan@2004

Pulse Code Modulation

- Human voice is digitized and sent as a digital signal.
- How many times it should be sampled?
 - Human voice has frequencies up to 4KHz.
 - Nyquist's theorem suggest that for accurate reproduction it must be sampled two times faster at a rate of 8000 times per second or precisely once in every 125 microsecond.
 - Each sample is sampled at 0-255 levels.
 - A voice channel requires to carry $8 \times 8000 = 65\text{Kbps}$ data.

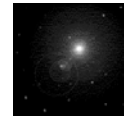
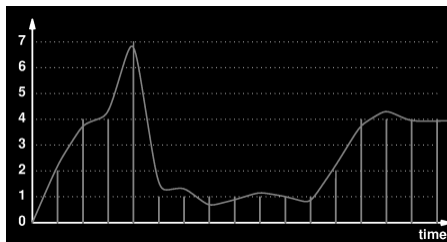

INTERNET
ENGINEERING

What if the network is not synchronous, such as delay at a junction is traffic dependant?

LECT-4b, S-4
IN2007B, javed@kent.edu
Javed I. Khan@2004

DS Telephone Circuits

Name	Bit Rate (Mbs)	Voice Circuits	Location
	.06400	1	
T1	1.5440	24	North America
T2	6.3120	96	North America
T3	44.736	672	North America
E1	2.0480	30	Europe
E2	8.4448	120	Europe
E3	34.368	480	Europe

- Telco sales these lines in the form of various trunk lines. The Backbone providers buy them to create Internet. These are sometime called DS levels. DS refers to Digital Signal Level Standard. T defines the multiplexing mechanism.

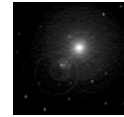

INTERNET
ENGINEERING

LECT-4b, S-5
IN2007B, javed@kent.edu
Javed I. Khan@2004

Digital Circuit & CSU/DSU

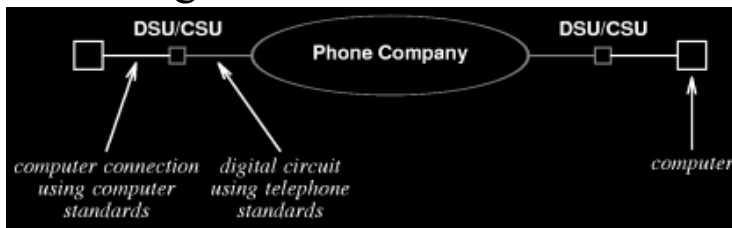

- To send computer data over telephone line, the asynchronous data must be converted into the right synchronous telephone standards.
- Data service Unit/ Channel Service Unit.
 - CSU handles line diagnostics, termination, control current surge, lightening, etc.
 - It prevent too many 1's!
 - DSU handles the computer side. It can use RS-232 (for less than 56K rate) or some other standard.

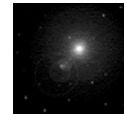

INTERNET
ENGINEERING

LECT-4b, S-6
IN2007B, javed@kent.edu
Javed I. Khan@2004

Capacity Adjustments

- Fractional Capacity
 - available at rates such as 64Kbps, 128Kbps, 9.6Kbps, 4.8Kbps, etc.
 - These are Time Division Multiplexed on T1.
- Intermediate Capacity
 - What if you need 2 T1?
 - Inverse Multiplexer
 - Separate CSU/DSU are required for each line.

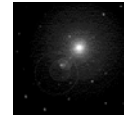
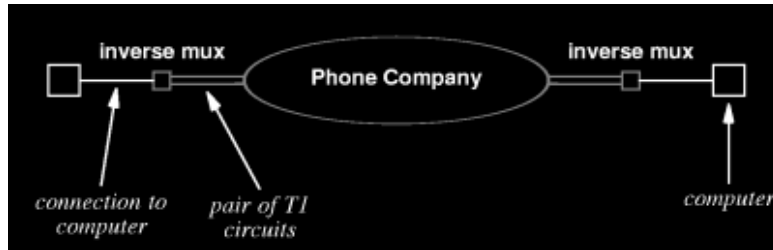

INTERNET
ENGINEERING

LECT-4b, S-7
IN2007B, javed@kent.edu
Javed I. Khan@2004

Highest Capacity Fiber Circuits

Optical Name	SONET Level	Payload (kbit/s)	Line (kbit/s)	Voice Circuits
OC-1	STS-1	48,960	51,840	810
OC-3	STS-3	150,336	155,520	2430
OC-12	STS-12	601,344	622,080	9720
OC-24	STS-24	1,202,688	1,244,160	194440
OC-48	STS-48	2,405,376	2,488,320	38880
OC-96	STS-96	4,810,752	4,976,640	
OC-192	STS-192	9,621,504	9,953,280	Internet2
OC-768	STS-768	38,486,016	39,813,120	2007 tested
OC-1536	STS-1536	76,972,032	79,626,120	
OC-3072	STS-3072	153,944,064	159,252,240	

- Synchronous Transport Protocols (STS) represent trunk circuits.
- OC is a special version of the standards for fibers.

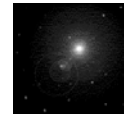

INTERNET
ENGINEERING

LECT-4b, S-8
IN2007B, javed@kent.edu
Javed I. Khan@2004

SONET/ SDH

- Before the breakup AT&T all carriers will use their own TDM. After the breakup in 1984 a standard was needed and developed.
- SONET Goals:
 - Carriers to interoperate within USA and with Europe & Japan.
 - Multiplex multiple digital channels T3 and up.
 - Support for operations, administration & maintenance (OAM).
- Synchronous Communication
 - Precisely controlled by highly accurate master clock 1 in 10^9 .
 - A frame must leave in 125 ms.

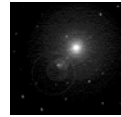

INTERNET
ENGINEERING

LECT-4b, S-9
IN2007B, javed@kent.edu
Javed I. Khan@2004

SONET

- Synchronous Optical Network frames carry these data.

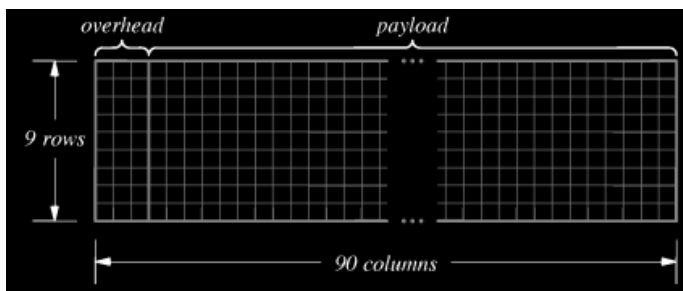

- The frame size is circuit dependent.
 - STS-1 (51.84 Mbps) contains 810 (9x90) 8-bit octates,
 - STS-3 holds 2430 8-bit octates.

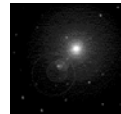

INTERNET
ENGINEERING

How the size is
determined?

LECT-4b, S-10
IN2007B, javed@kent.edu
Javed I. Khan@2004

SONET (contd)

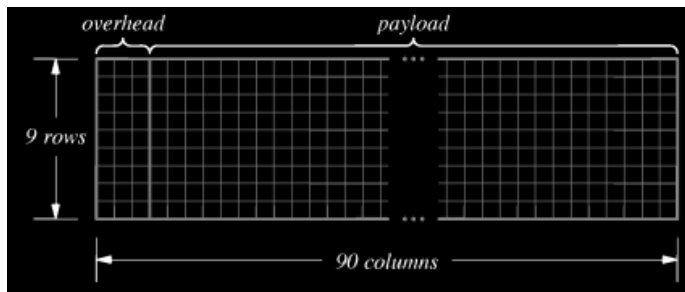

- One Frame must be sent in every 125 microsecond.
 - At STS-1 rate, 51.840 Mbps, exactly 6480 bits=810 octates need to be carried in 125 microsecond.
- Synchronous multiplexing
 - multiplexing without introducing delay.
- SONET is used for Point-to-Point data comm. But it can be used in other ways as well, such as in FDDI ring.

How the size is determined?

LECT-4b, S-11
IN2007B, javed@kent.edu
Javed I. Khan@2004

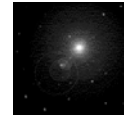

INTERNET
ENGINEERING

SONET (contd)

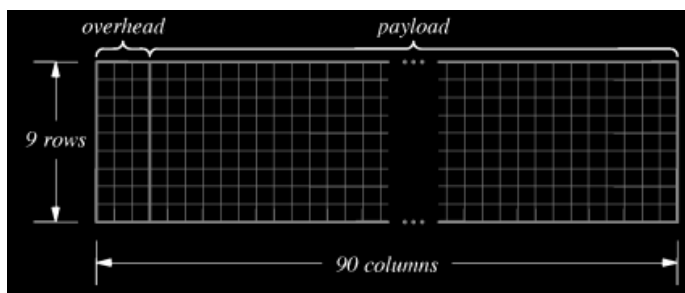

- The first three columns carry system management info.
- The first three rows contain section overhead.
- The next six contains line overhead.
- Frames are sent data or not. A frame with data is identified with fixed pattern in first two bytes.
- User payload can start anywhere in the frame. A pointer to first byte appears in the first row of line overhead.

LECT-4b, S-12
IN2007B, javed@kent.edu
Javed I. Khan@2004

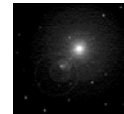

INTERNET
ENGINEERING

Last Mile

13

Local Subscribers Lines

- Leased lines provides the ability to send data across long distance. But, before Internet can be ubiquitous the problem of reaching every house hold have to be solved.
- Local Loop;
 - the last mile or a local subscribers carrier line connecting the phone company central office (CO) with the subscriber's place of business.
- Despite the dial-up modems, progress, the need of bandwidth has grown even faster.
- The voice bandwidth and signal-to-noise ratio dictates the ultimate limit of simple modems.

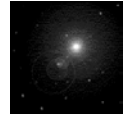

INTERNET
ENGINEERING

LECT-4b, S-14
IN2007B, javed@kent.edu
Javed I. Khan@2004

ISDN

- Integrated Service Digital Line
 - One of the first effort to provide large scale digital service.
 - Uses the same twisted-pair copper wire as telephones, no need to special wiring or equipment.
 - Offers 2B+D channels. B for digitized voice or compressed video.D for control.
 - Bandwidth $64+64+16=144$ Kbps + (16 signaling).
 - The two Bs can be combined into one
 - Uses TDM over single pair of wire.
- ISDN is an old technology and faces extinction from improved modems and other technologies.

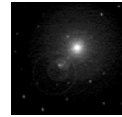

INTERNET
ENGINEERING

LECT-4b, S-15
IN2007B, javed@kent.edu
Javed I. Khan@2004

Asymmetric Digital Subscribers Line (ADSL)

- It has more download and smaller upload bandwidth.
 - 6.144 Mbps Down + 576 Kbps Up + 64 Kbps (control Up)
- It keeps the telephone as well.

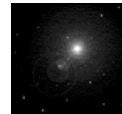
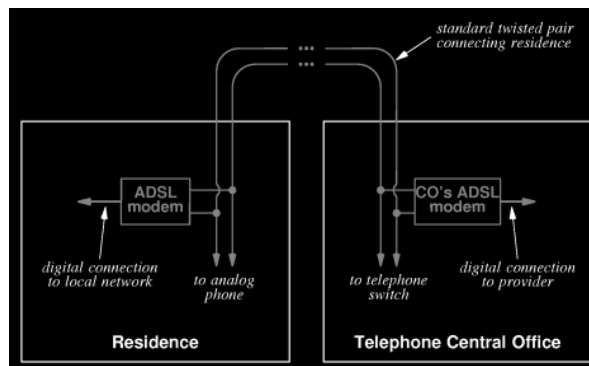

INTERNET
ENGINEERING

LECT-4b, S-16
IN2007B, javed@kent.edu
Javed I. Khan@2004

How ADSL Works

- Telephone lines are not designed for such high data rate!
- It does everything to evade interference.
 - Combines FDM and Inverse Multiplexing known as Discrete Multi-tone Modulation (DMT).
 - Divides the bandwidth into 286 sub-channels
 - assigns 255 down and 31 upstream.
 - Conceptually a separate modem runs on each of them.
 - Carriers are spaced 4.1325 KHz apart to avoid cross-channel interference.
 - It also does not use frequency from 0-4KHz. To avoid voice.
 - Each modem also tracks the error rate and adjusts the modulation scheme (quantization levels etc) dynamically with the noise in the sub-channels.
 - Does not guarantee a capacity, but is the best effort depending on the cable quality and local interference.
 - Effective rate varies in 32Kbps-6.4Mbps DN/32-640 Kbps UP

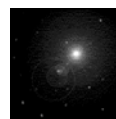

INTERNET
ENGINEERING

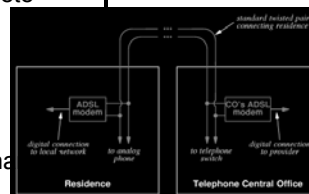

LECT-4b, S-17
IN2007B, javed@kent.edu
Javed I. Khan@2004

Other xDSLs

- Symmetric DSL (SDSL)
 - inverse ADSL is not easy to find so best choice for server farms.
 - Uses a somewhat different encoding technology.
- High rate DSL (HDSL)
 - 1.544 Mbps both directions.
 - Does it by restricting to shorter distances.
 - Requires two pairs of twisted pairs.
 - A one pair variant is HDSL2.
 - It can survive bridge-tap
 - Fails gracefully, works at half capacity when one wire fails, thus provides reliability to businesses.
- Very High DSL (VDSL)
 - 52 Mbps!
 - Requires special concentrator devices to be inserted in between.
- ADSL G.LITE
 - ITU standard for 1.5 Mbps/ 512Kbps (December 1999)

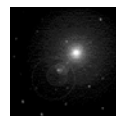

INTERNET
ENGINEERING

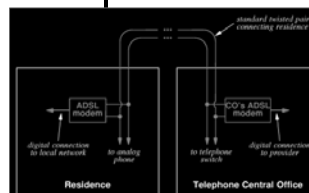

LECT-4b, S-18
IN2007B, javed@kent.edu
Javed I. Khan@2004

Cable Modem

- Cable Modem
 - A coax is better carrier than twisted pair.
 - CATV available at 80% residential units in USA.
 - Currently 1-450 MHz band is in use (can take upto ~1 GHz)
 - Divided into 6MHz television sub-channels.
 - Amplifies signal in the neighborhood.
 - A very good download broadcast media with high unused capacity.
- Limitations:
 - The FDM does not scale.
 - Capacity is divided by customers.
 - Actually unidirectional architecture
 - no upstream channel
 - amplifiers in between are unidirectional too.

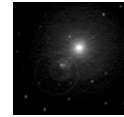

INTERNET
ENGINEERING

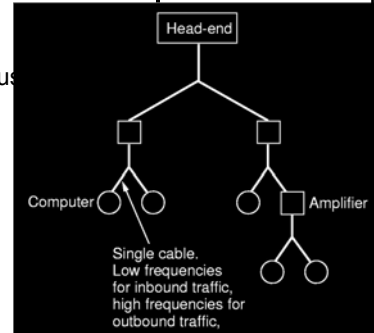

LECT-4b, S-19
IN2007B, javed@kent.edu
Javed I. Khan@2004

Wireless Mesh

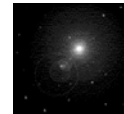

INTERNET
ENGINEERING

LECT-4b, S-20
IN2007B, javed@kent.edu
Javed I. Khan@2004

Wireless Mesh

- **First Generation of Wireless Mesh Networks**
 - One-radio "Ad Hoc" Wireless Mesh. In first-generation mesh products, a single radio provides both service (connection to individual user devices) and backhaul (links across the mesh to the wired or fiber connection), so wireless congestion and contention takes place at every node. Users soon discovered that only one or two radio "hops" were possible between connections to the wired or fiber Ethernet. Support is also very poor for Video and Voice applications because of excessive and varying delay (latency) across the network.
- **Second Generation of Wireless Mesh Networks**
 - Two-radio Wireless Mesh, shared backhaul. To solve these contention and congestion issues, second-generation mesh was developed by placing two radios in each node, combining an 802.11b/g service radio with an 802.11a backhaul radio. While this offered a performance improvement in terms of bandwidth over first-generation mesh, problems remain. With heavy user demand, there is still significant contention and congestion on the backhaul links. This limits the number of radio hops before another costly wired or fiber Ethernet connection is needed.

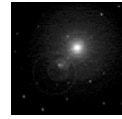

INTERNET
ENGINEERING



LECT-4b, S-21
IN2007B, javed@kent.edu
Javed I. Khan@2004

Wireless Mesh

- **Third Generation of Wireless Mesh Networks**
 - Three Radio with Multi-radio Wireless Backhaul. Third-generation mesh networking products add at least two physical radios for the backhaul. One backhaul radio is used to create a link to its upstream (nearer the wired source or "root") node. Another backhaul radio creates a link downstream to the next neighbor node. Unlike second-generation solution, these two radios may make use of different channels.
- **Mobile Ad-Hoc Networking(MANet)**
 - Mobile ad-hoc networking(MANet), and mesh networking are therefore closely related, but mobile ad hoc networks also has to deal with the problems introduced by the mobility of the nodes.
- Mesh networks are self-healing: the network can still operate even when a node breaks down or a connection goes bad. As a result, a very reliable network is formed. This concept is applicable to wireless networks, wired networks, and software interaction.

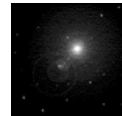

INTERNET
ENGINEERING

LECT-4b, S-22
IN2007B, javed@kent.edu
Javed I. Khan@2004

3G Wireless Mesh

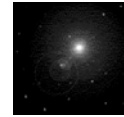
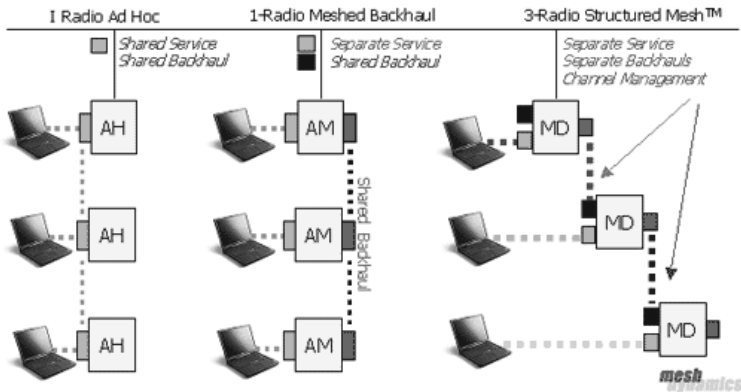

INTERNET
ENGINEERING

LECT-4b, S-23
IN2007B, javed@kent.edu
Javed I. Khan@2004

The 1/N vs. the 1/2N Controversy

1-Radio String of Pearls

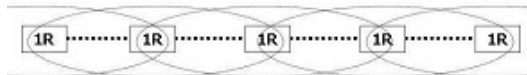

- A service node receives and then pauses to send. Thus the bandwidth is halved. A client of it thus has $\frac{1}{2}$ bandwidth to forward. On the other hand this client has again $\frac{1}{2}$ of the bandwidth to its own client. Thus in each hop the effective bandwidth halves.
- Thus the performance decreases in order of $(\frac{1}{2})^N$

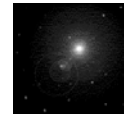

INTERNET
ENGINEERING

LECT-4b, S-24
IN2007B, javed@kent.edu
Javed I. Khan@2004

Bandwidth Slide in Mesh

Bandwidth Degradation over multiple hops of 1-Radio Mesh Backhauls

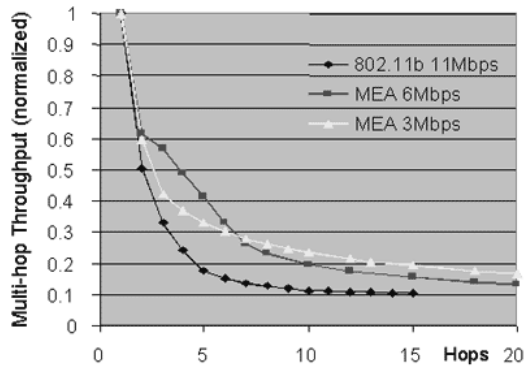

Source: MeshNetworks® Presentation by Rick Rotondo, Oct 20, 2004, San Francisco

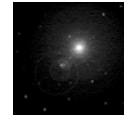

INTERNET
ENGINEERING

LECT-4b, S-25
IN2007B, javed@kent.edu
Javed I. Khan@2004

Bandwidth Comparison

Bandwidth Comparison Of Structured Mesh™ vs. Competing Mesh Architectures

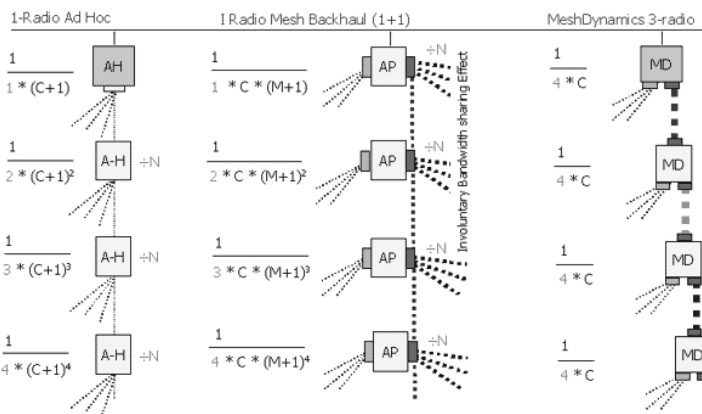

N = 4 (Number of Hops)
 C = avg number simultaneous 11b/g clients per node
 M = avg number contending 11a neighbors in 1-radio mesh backhaul
 Bandwidth Degradation rule applied: 1/N (results worse with 1/2^N)

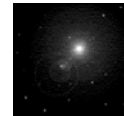

INTERNET
ENGINEERING

LECT-4b, S-26
IN2007B, javed@kent.edu
Javed I. Khan@2004

Other Local Loop Technologies

- Municipality Wireless Mesh (Mu-Fi)
 - Wi-Fi 802.11
 - Wi-Max 802.16
- Fiber To The Premises (FTTP)
 - 1GB at home.
- Satellite
- Cellular Technology
 - CDMS2000
 - GSM/4G (100 Mbit/s-1 Gbit/s)



T-4b, S-27
IN2007B, javed@kent.edu
Javed I. Khan@2004

CWDM & DWDM

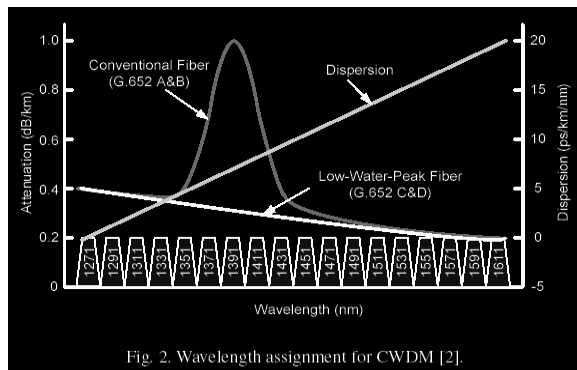

Fig. 2. Wavelength assignment for CWDM [2].

- Wavelength spacing of more than 20 nm is generally called coarse WDM(CWDM). A total of 18 CWDM channels are available on a fiber.
- A newer technology Dense WDM (DWDM) has wavelength spacing that is far lesser than that of CWDM, typically less than 3.2 nm. Today's DWDM systems use 50 GHz or even 25 GHz channel spacing for up to 160 channel operation.

INTERNET
ENGINEERING

LECT-4b, S-28
IN2007B, javed@kent.edu
Javed I. Khan@2004

Passive Optical Network (PON)

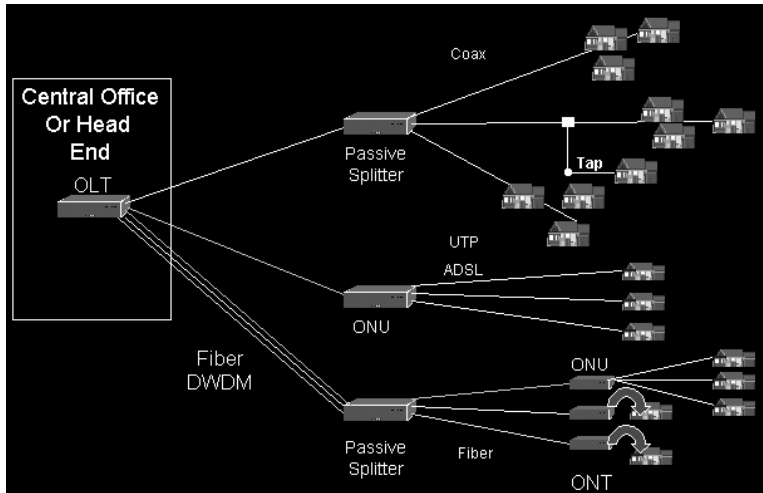

INTERNET
ENGINEERING

LECT-4b, S-29
IN2007B, javed@kent.edu
Javed I. Khan@2004

Passive Optical Network (PON)

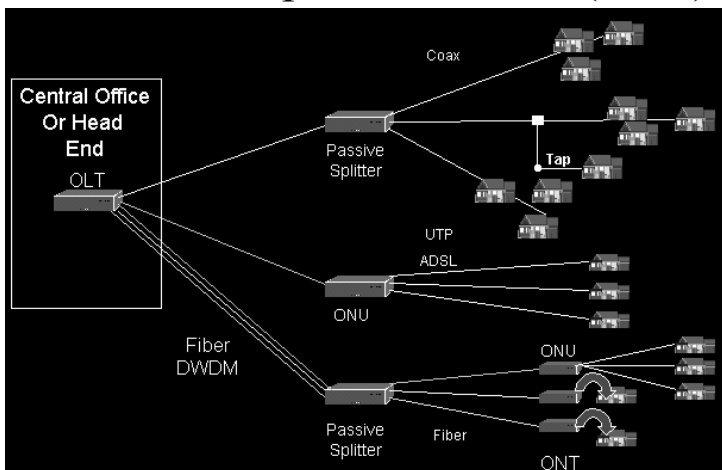

INTERNET
ENGINEERING

- PON network elements consist of Optical Line Terminals (OLTs), Optical Network Terminals (ONTs), Optical Network Units (ONUs), and passive splitters. As illustrated in [Figure 1](#) the OLT is located in the carrier's Central Office (CO) in a telco application, or in the CATV provider's headend.

LECT-4b, S-30
IN2007B, javed@kent.edu
Javed I. Khan@2004

Passive Optical Network (PON)

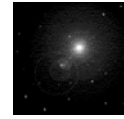

INTERNET
ENGINEERING

- Optical Line Terminals:
 - The OLT can either generate optical signals on its own, or pass optical signals (e.g., SONET or DWDM) from a collocated optical crossconnect or other device, broadcasting them downstream through one or more ports.
- Optical Network Terminals:
 - An ONT is used to terminate the circuit inside the premises in an FTTP (Fiber-To-The-Premises) scenario, where it serves to interface the optical fiber to the copper-based inside wire.
- Passive Optical Splitter
 - The passive optical splitter sits in the local loop between the OLT and the ONUs or ONTs. The splitter divides the downstream signal from the OLT at the network edge into multiple, identical signals that are broadcast to the subtending ONUs. .

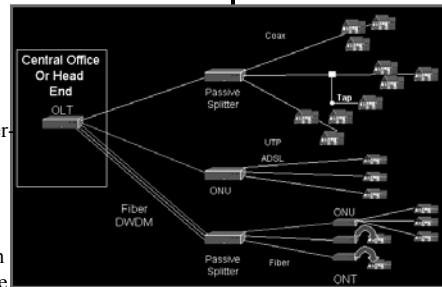

LECT-4b, S-31
IN2007B, javed@kent.edu
Javed I. Khan@2004

Passive Optical Network (PON)

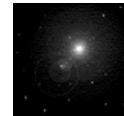

INTERNET
ENGINEERING

- Optical Network Unit
 - An ONU is used in an FTTC (Fiber-To-The-Curb) scenario, in which case the fiber stops at the curb, with the balance of the local loop being provisioned over embedded copper -- UTP in conventional telco networks and coax in CATV networks.
 - An ONU also is used in an FTTN (Fiber-To-The-Neighborhood) scenario, in which it is positioned at a centralized location in the neighborhood, with the balance of the local loop being provisioned over embedded coax or UTP..
- Each OLT/ONU is responsible for determining which data are intended for it, and for ignoring all others.
- Upstream signals are supported by a time-division multiple access scheme, with the transmitters in the ONUs operating in burst mode. FSAN supports both symmetric and asymmetric modes.

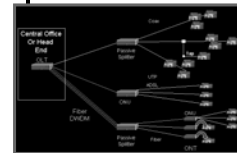

LECT-4b, S-32
IN2007B, javed@kent.edu
Javed I. Khan@2004

Composite PON (CPON)

- Separate WDM waves down stream and one TDMA upstream wave upstream.

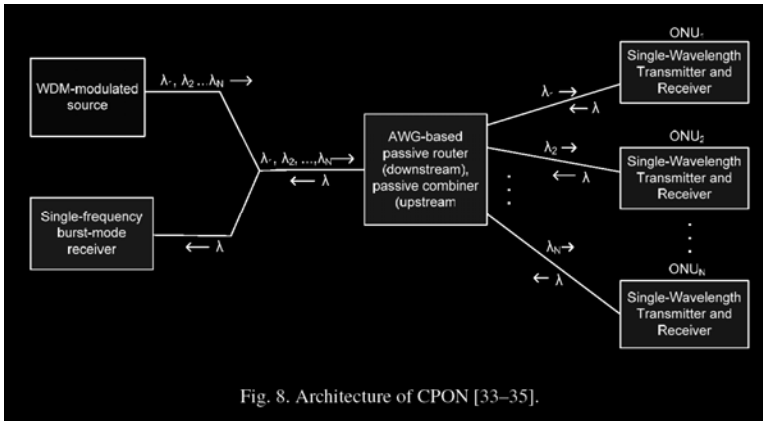
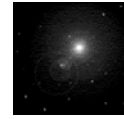

Fig. 8. Architecture of CPON [33–35].



INTERNET
ENGINEERING

Single Frequency
Laser at ONU is
expensive

LECT-4b, S-35
IN2007B, javed@kent.edu
Javed I. Khan@2004

Local Access Router Network (LARNET PON)

- Uses inexpensive broad source LED as source at ONUs. The AWG slices it and puts into different optical bands. All customer ONU units can be identical.

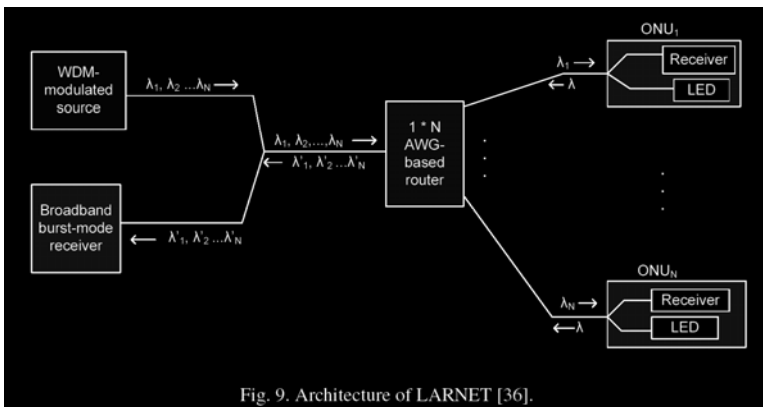
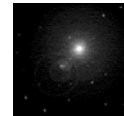

Fig. 9. Architecture of LARNET [36].



INTERNET
ENGINEERING

Spectral slicing
at AWG has high loss.
Distance from OLT
to ANU is limited.

LECT-4b, S-36
IN2007B, javed@kent.edu
Javed I. Khan@2004

Remote Interrogation of terminal Network (RITENET)

- Instead of a LED a cheap modulator (refractor) is used to modulate a signal initiated by the AWG router. Thus, the device is very cheap and the distance limitation is not there. Time sharing in upstream and downstream. Bandwidth is symmetric.

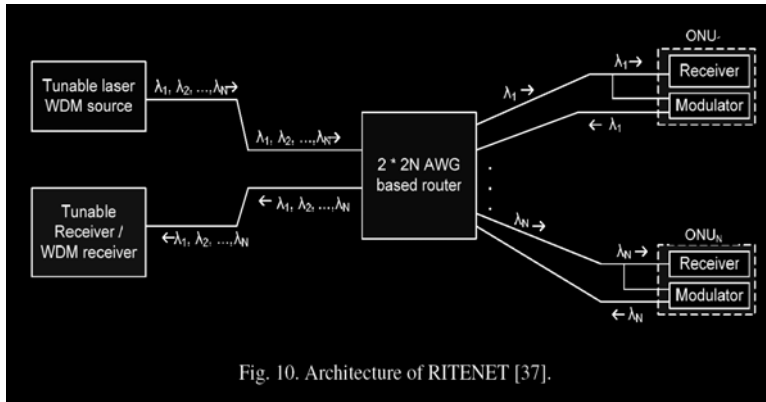
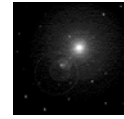

Fig. 10. Architecture of RITENET [37].



INTERNET
ENGINEERING

Still expensive
at sender end.
Double fiber
at customer end.

LECT-4b, S-37
IN2007B, javed@kent.edu
Javed I. Khan@2004

Multistage AWG

- Needs more ONUs and more users per ONU. Multistage AWG addresses the problem.

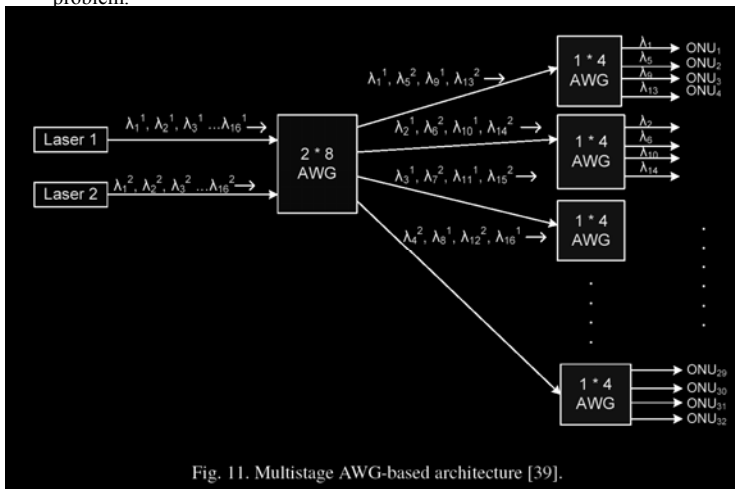
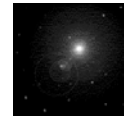

Fig. 11. Multistage AWG-based architecture [39].



INTERNET
ENGINEERING

LECT-4b, S-38
IN2007B, javed@kent.edu
Javed I. Khan@2004

DWDM Super PON

- PONs also have distance limitations such as EPON is 20km and the maximum number of nodes supported is 32. Super-PON (SPON) covers a range of 100 km, and with optical amplifies splitting ratio of 2000. Each direction uses separate DWDM channels.

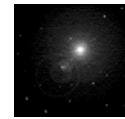
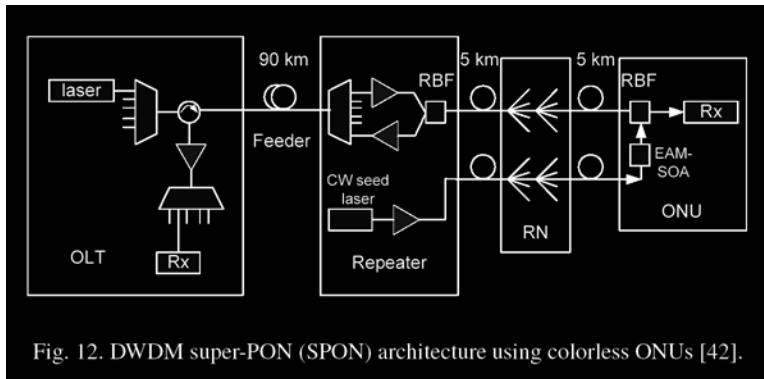

INTERNET
ENGINEERING

Optical amplifiers
are not passive.

LECT-4b, S-39
IN2007B, javed@kent.edu
Javed I. Khan@2004

WDM-PON Comparisons

Table 1. Comparison of Various WDM-PON Architectures

	CPON [33]	LARNET [36]	RITENET [37]	Multi-Stage [39]	Super-PON [42]	Success-DWA [43]
Main Objective of architecture	AWG based basic system	Reduce ONU Cost	Reduce ONU Cost	Scalable PON Wide-area service	Long-distance Wide-area service	Scalable PON Throughput increment
Sharing of Fiber	Up/down shared or separate	Up/down shared	Up/down separate	Dependent on upstream option	Up/down shared	Up/down shared
Sharing of Wave-length	down	1 λ /ONU	1 λ /ONU	Dependent on upstream option	Share (TDMA)	- Shared among ONUs
	up	Shared (TDMA)	Shared (TDMA, CSMA/CD)		Share (TDMA)	- Up/down shared (TDMA, dynamic allocation)
Scalability	Poor	Poor	Poor	Good	Good	Excellent
Cost of user terminal (ONU)	Poor (DFB LD)	Good (LED)	Good	Dependent on upstream option	Poor	Poor
Cost of deployment	Good	Good	Poor	Very poor	Good	Poor
Distance (OLT-ONU)	Average	Poor	Very poor	Average	Excellent (~ 100 Km)	Average

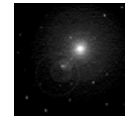

INTERNET
ENGINEERING

LECT-4b, S-40
IN2007B, javed@kent.edu
Javed I. Khan@2004

Ethernet in the First Mile (EFM)

- Ethernet in the First Mile (EFM), also known as IEEE 802.3ah, is a collection of protocols specified in IEEE 802.3, defining the Ethernet in the Access networks, i.e. First/Last Mile.
- EFM allows continuous standard Ethernet network across the globe, as well as to last mile eliminating non-native transport such as Ethernet over ATM from the Access Networks.
- EFM is not a new Ethernet. It defines how Ethernet can be transmitted over new media types:
 - Voice-grade copper.
 - Long wavelength single fiber (as well as long wavelength dual-strand fiber)
 - Point-To-Multipoint (P2MP) fiber. Ethernet over Passive Optical Networks (EPON).
- EFM also addresses other issues, required for mass deployment of Ethernet services, such as Operations, Administration & Management (OAM) and compatibility with existing technologies (e.g. spectral compatibility for copper).

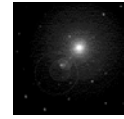

INTERNET
ENGINEERING

LECT-4b, S-41
IN2007B, javed@kent.edu
Javed I. Khan@2004

Ethernet Physical Layer (PHY) Standards

- The EFM defines the following new Ethernet physical layer (PHY) interfaces:
- EFMC - EFM Copper
 - **2BASE-TL** -- Full-duplex long reach Point-to-Point link over voice-grade copper wiring., delivers a minimum of 2 Mbit/s over distances of up to 2700 m (9 kft), over a single copper pair.
 - **10PASS-TS** -- Full-duplex short reach Point-to-Point link over voice-grade copper wiring. 10PASS-TS PHY can deliver a minimum of 10 Mbit/s over distances of up to 750m (2460 ft), over a single copper pair.
- EFMF - EFM Fiber
 - **100BASE-LX10** -- point-to-point 100 Mbit/s Ethernet links over a pair of single-mode fibers up to at least 10 km.
 - **100BASE-BX10** -- point-to-point 100 Mbit/s Ethernet links over an individual single-mode fiber up to at least 10 km.
 - **1000BASE-LX10** -- point-to-point 1000 Mbit/s Ethernet links over a pair of single-mode fibers up to at least 10 km.
 - **1000BASE-BX10** -- point-to-point 1000 Mbit/s Ethernet links over an individual single-mode fiber up to at least 10 km.
- EFM PON - EFM Passive Optical Network
 - **1000BASE-PX10** -- P2MP 1000 Mbit/s Ethernet links over PONs up to at least 10 km.
 - **1000BASE-PX20** -- P2MP 1000 Mbit/s Ethernet links over PONs up to at least 20 km.

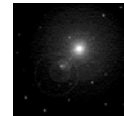

INTERNET
ENGINEERING

LECT-4b, S-42
IN2007B, javed@kent.edu
Javed I. Khan@2004

Newest Trunk Technology



LambdaRail (2006-2007): A high-speed national computer network in the United States that runs over fiber-optic lines, and is the first transcontinental Ethernet network.

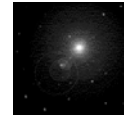

INTERNET
ENGINEERING

LECT-4b, S-43
IN2007B, javed@kent.edu
Javed I. Khan@2004

Next Topic: WAN