

FEDERAL AVIATION AGENCY SPECIFICATION

CENTRAL COMPUTER COMPLEX FOR ENGINEERING MODEL
OF
NATIONAL AIRSPACE SYSTEM
(ENROUTE)

1. SCOPE

1.1 Scope.- This specification defines a Central Computer Complex (CCC) for use in the engineering model of the National Airspace System (NAS). The CCC equipment includes digital computing elements, memory elements, input/output elements, interconnection equipment, peripheral-device adapters for equipment external to the CCC, and computer-oriented peripheral devices.

1.1.1 The CCC functions to process a large volume of input data such as radar/beacon, flight plans, controller inputs, and to present results to controllers in the proper form via electronic displays and printers.

1.1.2 The salient features required of the CCC are extremely high reliability for operation 24 hours a day, seven days a week, capability for being configured from one basic family of equipment to cover a wide range of functions and flight loading (to allow progressive system implementation and to serve both large and small facilities) in an efficient, economical manner, with a design that inherently insures fail-safe and fail-soft operation (see 6.2).

1.1.3 Attached to this specification are Appendices A through F which provide related background and technical data which are referenced by this specification. Section 6 lists the titles of these appendices. Section 6 also includes definitions and an index.

1.2 Deliverable Items.- The following items shall be furnished in quantities and at the times specified.:

<u>Item</u>	<u>Key Reference Paragraphs</u>
(A) Central Computer Complex System, including as a minimum the items listed below:	

<u>Item</u>	<u>Key Reference Paragraphs</u>
(a) Central Computer Complex including computing, memory and input/output elements	3.2.1, 3.3.2, 3.3.3, 3.5.1, 3.5.2, 3.5.3
(b) Peripheral-device adapters	3.4.1 through 3.4.3.3
(c) Disk and drum units (if required)	3.2.1.4.2, 3.3.2
(d) Cables	3.12
(e) Magnetic tape drives including tape control units	3.2.1.9.1
(f) Card reader	3.2.1.9.2
(g) Card punch	3.2.1.9.3
(h) Printer, high speed	3.2.1.9.4
(i) Monitor console(s) or supervisory console(s), or both, printer(s), and typewriter(s), or both, and paper tape reader/punch	3.2.1.10
(j) Power supply units	3.2.2
(k) Off-line test equipment	3.2.1.10, 3.8.3.4, 4.4
(l) Type I Progress Reports	3.11.4
(m) Instruction books, manuscript and final	3.11.10, 3.11.10.1, 3.11.10.1.1
(n) Design data, preliminary and revisions	3.11.5, 3.11.5.6
(o) Interface design and data	3.4.2, 3.11.5, 3.11.5.3
(p) Recommended acceptance test titles and data to be taken	3.11.8
(q) Test specification	3.11.8
(r) Test reports, preliminary test data sheets, and final test data sheets	3.11.9
(s) Test routines: Software	4.2.2.4.1
Documentation	4.2.4
(t) Utility System: Software: Assembler	3.7.1.1, 3.7.1.5
Loaders	3.7.1.2, 3.7.1.5
Dumps	3.7.1.3, 3.7.1.5
Program debugging aids	3.7.1.4, 3.7.1.5
Documentation: Assembler reference manual	3.7.2.1, 3.7.2.2
Assembler operator's manual	3.7.2.1, 3.7.2.2
Specification, assembler	3.7.1.5, 3.7.2.2
Specification, loaders	3.7.1.5, 3.7.2.2
Specification, dumps	3.7.1.5, 3.7.2.2
Specification, program debugging aids	3.7.1.5, 3.7.2.2
(u) Off-line maintenance programs: Software	3.7.3.1.1, 3.8.3.3.3
Documentation	3.7.3.1.1
(v) Programmer's reference manual	3.7.2

<u>Item</u>	<u>Key Reference Paragraphs</u>
(B) Installation services	3.9
(C) Site preparation specification	3.9
(D) Installation documents	3.11.7
(E) Maintenance services	3.8.4
(F) Maintenance records	4.3
(G) Maintenance log	3.8.4.1
(H) Recommended spare parts list	3.8.4.1
(I) Index of drawings and technical memoranda	3.11.6
(J) Drawings and technical memoranda	3.11.6

2. APPLICABLE DOCUMENTS

2.1 General.- The following documents form a part of this specification to the extent specified herein.

2.2 Applicable Specifications

2.2.1 FAA Specifications

- (a) ER-D-406-010 General Requirement for Data Processing and Display Equipment (Prototype) - January 12, 1962
- (b) SRDS-1 Specification for Contractor's Technical Reports - December 17, 1962
- (c) SRDS-N/M-1 The SRDS Network/Milestone Technique - February 1963

2.2.2 MIL Specifications

- (a) MIL-I-26600 (USAF) Interference Control Requirements Aeronautical Equipment - June 2, 1958
Amendment No. 2 - May 9, 1960

2.3 Precedence of Documents.- When requirements of the contract, this specification, or subsidiary documents are in conflict, the following precedence shall apply:

- (a) Contract.- The contract shall have precedence over all other documents.
- (b) Specification.- This specification shall have precedence over all subsidiary documents referenced herein.

3. REQUIREMENTS

3.1 Extent of Work.- The contractor shall provide all necessary services and materials to design, fabricate, test, deliver, and install the equipment as required by this specification in the quantities and at the times required by the contract. Any feature or item necessary for proper operation in accordance with the requirements of the contract shall be incorporated even though that item or feature may not be specifically described herein. In addition, the contractor shall provide all necessary services and material to prepare, reproduce, and provide engineering analyses, reports, computer programs, and documentation as specified herein.

3.1.1 General.- The NAS CCC shall be:

- (a) An "off-the-shelf" system (3.2.1.1);
- (b) A system that needs only a few hours of down time to expand to meet changing needs;
- (c) Three different configurations that can be effectively and efficiently employed to meet the data processing workload of three levels of flight and function loading as indicated in this specification;
- (d) A design that will permit use of a single executive program located in active shared memory;
- (e) A highly reliable system that monitors its elements and detects failures;
- (f) A system with sufficient memory, arithmetic and control, and input/output elements on-line so that element failures will result in "failing safely" and subsequently "failing softly";
- (g) A system that minimizes programing, training, maintenance, and logistic support in quantity and personnel skill levels required for a nationwide implementation; and
- (h) A system that conforms to certain minimum hardware standards that are separately stated.

3.1.2 Bounds of the Central Computer Complex.- The bounds of the Central Computer Complex shall include digital computing elements, memory elements, input/output elements, the interconnection between these elements, computer-oriented peripheral equipment, peripheral device adapters containing such components as data buffers, demultiplexers, and equipment for word assembly and formatting, and any other hardware item required to properly interconnect the computer I/O elements to the Government-furnished radar digitizers, inter-facility digital data transfer circuits, teletypewriter circuits, controller keyboards, and high-speed printers. The equipment required for data storage, transfer, and formatting between the computer I/O channel and the Government-furnished plan-position displays and the tabular displays is

not included as a part of this CCC requirement; however, the contractor shall furnish the necessary I/O channels for the number of such displays used in accordance with his peripheral-device-adapter concept. Figure 3-1 indicates in block form the bounds of the CCC.

3.1.3 Description of the Data Processing Functions.- As background to this specification, Appendix E describes the data processing functions to be performed by the CCC. In general, the CCC will accept and process inputs from external devices, perform internal data processing, and prepare and transmit outputs to external devices for the generation of displays, printouts, etc. These input/output transfers, the processing of inputs, the preparation of outputs, and the internal processing will be carried out largely on a cyclic basis. The data processing workload required by the ATC functions is described in 3.3. The workload requirements of 3.3 are divided into the following data processing areas: flight plan data processing, surveillance data processing, and output data processing. Each of the data-processing areas is further broken down into a set of functions.

3.2 Hardware Requirements.- This section of the specification delineates certain hardware requirements for this equipment. The nature of the ATC data processing load, together with reliability and redundancy considerations as contained in other sections of this specification, may require that these standards be exceeded. These standards apply to each of the system configurations specified herein, except that for the 100-flight configuration (3.5.3), it shall not be necessary to add a third element of any type to provide the "fail-softly" feature where two elements would otherwise suffice.

3.2.1 CCC Equipment Design.- The CCC shall be a high-speed, general-purpose, digital, solid-state, stored-program data processing system. Its design shall permit operation with a single executive program which assigns tasks to individual computing elements on the basis of first available, so that no single computing element is critical to the operation of the system.

3.2.1.1 Off-The-Shelf Elements.- A major requirement of the equipment is that the CCC elements shall be "off-the-shelf." The following requirements apply:

- (a) Programmer and assembler reference manuals for the CCC must be available in accordance with software documentation requirements of section 3.7.
- (b) In the event the Government requires a program assembly debugging facility in any request for proposals in which this specification is a part, the contractor shall provide a scaled-down facility for program assembly and debugging. Elements identical to those used in the CCC are not mandatory, provided the computer complex offered adequately simulates the CCC for debugging purposes. If elements other than identical to those used in the CCC are furnished, the contractor shall provide any auxiliary assembler software necessary to accomplish program assembly at the debugging facility.

3.2.1.2 Modular Hardware Design.- Each specified CCC configuration shall be modular. The term modular is defined and described by the following characteristics:

- (a) Capability of being expanded independently in the three major data-processing areas of input/output transfer, computing speed, and active shared memory capacity;
- (b) Failures to be on a modular unit basis in terms of the effect on system capacity as opposed to complete data processor or system failures:
 - (1) Input/output modular failure degrades only the I/O transfer capability of the system, but does not knock out any peripheral device, affect the computing speed capability of the system, nor lower its active memory capacity;
 - (2) Computing (arithmetic and control) module failure reduces only the computing speed capability of the system, but does not reduce I/O transfer capability or active shared memory capacity;
 - (3) Active shared memory module failure reduces only the memory capacity by that amount, but does not reduce computing speed and I/O transfer capability.
- (c) System capability, both in hardware and software sense, exists for utilizing excess capacity in the three major data-processing areas for extra system reliability. This is not to be interpreted as the concept of active and switchable standby units, but rather one where the design and configuration permit all units to operate on-line in the system such that system confidence checks lead to a dynamic, fast response capability for system recovery from active module failures. A modular system, therefore must be capable of monitoring the status of its major elements and defining its capability with reference to a pre-established table (on-line elements and aircraft load vs. functional capability for the particular environment) to permit dynamic system recovery.

The term "element" as used elsewhere in this specification, when referring to computing, I/O, or shared-memory functions, shall be considered as synonymous with "module."

3.2.1.3 Use of Two Types of Data-Processing Machines.- The use of either one or two (but no more than two) data-processing machine types in the total of three required flight configurations will be acceptable, provided that programming is identical for each machine type and expandability requirements (3.2.1.6) are met.

*We
saw*

3.2.1.4 Redundancy of CCC Elements.- The number of elements of each type shall be determined for each configuration using the load and timing tables of appendices A, B, C, and D. These configurations shall reflect the capabilities of the particular elements of which they are composed, as well as the peak load of each complex (3.5.1, 3.5.2, 3.5.3). To each such complex, it is required that at least one additional element of each type be added as a redundant element to provide backup in case of failure under peak load conditions. As an example, if it is found that the system approach requires three memory elements in a complex, then at least four such elements shall be used. In addition, the system shall be capable of recovery by program control such that failures are detected and system recovery is effected without manual intervention. This requirement results, with certain exceptions, in the prohibition of any single (non-duplicated) elements in the system. Thus there shall be multiple memory, input/output, and computer elements in each proposed CCC configuration regardless of minimum requirements determined from the load and timing charts. This multiplicity also extends to the number of independent paths through any I/O device to any system-oriented peripheral devices. The permissible exceptions to this requirement for multiplicity are the following computer-oriented peripheral devices: card reader, card punch, line printer, paper tape reader/punch, and keyboard entry device (for computer servicing, not part of system functional operation) where the requirement is for only one of each type. Sections 3.6 and 3.8 may cause the required number of redundant elements or channels, or both to exceed the minimum requirement as stated and have precedence over these minimums.

3.2.1.4.1 Redundancy of Peripheral-Device Adapters.- Any proposed peripheral-device adapter units for reading in or out of teletypewriters, digital data transfer devices (including radar/beacon digitized data transfer devices), manual keyboard entry devices, and high speed printers shall also contain sufficient redundancy to provide backup in case of a single failure. The exact means of achieving this shall conform with requirements for the particular input or output adapter devices.

3.2.1.4.2 Redundancy of Bulk Storage Devices.- The inclusion of bulk storage devices such as magnetic drums and disk files pose unique problems in the area of data recovery in case of failure. The contractor shall provide a means of insuring redundant operation in line with the preceding requirements of this section for any such devices employed in his configuration.

2. 3.2.1.5 Parity Check Feature.- As a minimum, a single parity bit per computer word shall be utilized in all CCC memory/input-output/computer transfers and storage. All transmissions to and from system-oriented peripheral devices, although not yet defined, will also include at least one parity bit per transmitted character, byte, or word. The computer-oriented peripheral devices should, as a desirable feature, also adhere to this one-parity-bit-per-transmission requirement; however, other checking means for transmissions to and from computer-oriented peripheral devices will be considered. The magnetic tape units, however, shall contain a parity check facility for both reading and writing tape with a parity bit stored per stored tape character.

3.2.1.6 Expandability.- The two smaller flight load configurations specified--100 and 200 flights--shall be expandable so that either may be converted to the 325-flight configuration by the addition of sufficient elements identical to those making up the configurations initially. However, should two types of machines be used to cover the range as permitted by 3.2.1.3, the expandability requirement shall be that the 100-flight configuration be expandable to at least a 150-flight configuration as defined by the load tables of Appendix B with $n=150$, and the 200-flight configuration be expandable to the 325-flight configuration.

3.2.1.7 I/O Channel Capabilities.- At least one of the I/O channels, with required redundancy, shall be capable of a high data transmission rate--approaching the speed of the basic equipment element (memory--I/O--computing) data-transfer rate. The data-rate capability of the remaining channels shall be higher than the rate required by the job to be performed. All channels shall also permit low-data-rate transmission. All channels shall be compatible with the asynchronous requirements of the system's peripheral devices. The burden of adjusting to variations in data-transfer timing among peripheral devices shall be assumed by the CCC system. At least one I/O channel shall permit connecting directly into other I/O channels in order to permit the transfer of data with nearby similar computer systems. Peripheral devices sharing a common I/O channel shall not hang up the I/O element or channel logic when turned on and off. Further, no commonly encountered component failure in a single peripheral device shall tie up the I/O facilities so that other devices sharing the same element or channel are also incapacitated.

3.2.1.8 Shared Memory.- Shared primary memory shall be provided for active storage of the executive program, object programs and routines, configuration status, ATC information, and other information that will be needed to perform any program functions which can be assigned to the computing elements by the executive program. Shared primary memory, as used here, is a high-speed, random-access memory that is available to each on-line active computing element within the normal memory access cycle time.

Common memory

3.2.1.9 Computer-Oriented Peripheral Devices

3.2.1.9.1 Magnetic Tapes.- At least eight magnetic tape drives, including as a minimum two tape control units, shall be provided. Four of these drives shall be reserved during system operation for data recording. If the executive control concept, maintenance, and redundancy requirements require tape drives in excess of the remaining four, this additional requirement shall be accommodated. Local assignment of any tape drive to any selection code is required. At least two tape drives shall produce tapes for and accept tapes from IBM-729 Mod. II and Mod. IV tape drives. The CCC shall provide for automatically loading program routines from tape, with no pre-stored information being required to initiate such a function. One acceptable method would be a single "load-from-tape" control located on the monitor console, which would perform the following functions;

- (a) Cause a block of data of fixed length to be read from a pre-selected tape and stored in a fixed set of locations in primary storage; and

- (b) Execute the instruction in the first such primary storage location and continue appropriate execution of subsequent instructions.

It is recognized that this requirement can be fulfilled through a number of hardware techniques; techniques other than that described above will be considered.

3.2.1.9.2 Card Reader.- A card reader shall be provided that reads 80-column, 12-row, rectangular-hole punched cards at a speed of not less than 250 cards per minute.

3.2.1.9.3 Card Punch.- A card punch shall be provided that punches 80-column, 12-row, rectangular-hole punches cards at a speed of not less than 100 cards per minute.

3.2.1.9.4 Printer.- A high speed line printer with the following minimum characteristics shall be provided:

- (1) At least 120 characters per line (i.e., 120 printable columns);
- (2) At least 300 lines per minute printing speed; and
- (3) A character set capable of performing the data processing functions specified in section 3.3. (It is anticipated that between 50 and 64 different printable characters will be required; the specific character set will be specified at a later date.)

3.2.1.10 Control and Maintenance Elements.- The specific system maintenance requirements are discussed in section 3.8. The succeeding paragraphs of this section include those portions of the control and maintenance elements that are considered minimum requirements based upon the NAS concept and upon the characteristics of off-the-shelf equipment. The control and maintenance elements of the CCC shall provide the facilities and permit:

- (a) External control of the data processing system;
- (b) Direct entry to and hard copy output from the CCC data processing system;
- (c) Automatic monitoring of the operational status of all elements at one centrally located monitor console area, including audible alarm whenever a mode change occurs;
- (d) Detecting equipment errors, and localizing and repairing faults; and
- (e) Debugging and modification of programs.

easy

The equipment shall consist of:

- (a) Monitor console(s) or supervisory console(s), or both, printer(s) or typewriter(s), or both, and paper tape reader/punch;
- (b) Error-detection logic; and *and redundancy!*
- (c) Off-line test equipment (3.8.3.4).

This equipment and associated maintenance programs shall provide the error detection and repair necessary to insure a system mean down time as specified in section 3.6.

3.2.1.10.1 Monitor Console(s) or Supervisory Console(s), or both.- The monitor console(s) or supervisory console(s), or both, shall have the following control and monitoring facilities. These hardware items shall be supplied in sufficient quantities to meet the requirements of the operational ATC system in addition to the stated additional requirements for a maintenance subsystem and other off-line data processing facilities.

- (a) Keys (or switches) to control the basic operations of the CCC consistent with the requirements for operation in either a real-time or program debugging environment;
- (b) A facility for manual keyboard entry and printout of messages in the vicinity of the monitor console(s);
- (c) A paper tape reader/punch that will read punched paper tape and punch a paper tape copy when manual entry of data is taking place at the keyboard entry device; and
- (d) Indicators to visually display mode status, error conditions, and contents of selected registers.

It is recognized that many of the features of the console(s) will be dependent upon both the hardware and software configurations chosen. Because of this, all desirable features of a console cannot be listed. The following is a partial list of desirable features of a console functioning in an ATC environment.

- (a) Keys (or switches) should be provided to start and stop operation, select modes of operation (i.e., run, single cycle, alter, and like operations), directly enter data (e.g., load from card reader, load from tape, or load from typewriter);
- (b) Visual indication of all equipment faults should be provided, localized to at least the basic elements (e.g., computing units, I/O units, or memory units)--further localization shall be provided for within each basic element;

- (c) Facilities to control and provide status indications (e.g., lights, printouts, or audible alarms) of maintenance program operation should be provided for on the monitor console or on a nearby printer;
- (d) An audible indication should be provided when a fault or program stall condition occurs. The audible indication should then be turned off manually, but should be automatically reactivated to sense for the next fault or stall condition;
- (e) Sense and branch switches should be provided for altering the program flow; and
- (f) Console(s) should operate in a multi-program environment. Additional switches and control logic (or entire consoles) should be supplied where necessary.

3.2.1.10.2 Error-Detection Logic.- The error-detection logic of the CCC shall automatically detect and indicate to the monitor console faults occurring within each element of the CCC which would prevent proper system operation. All error-detecting features shall function so that any failure of error-detecting circuitry will indicate a solid error.

3.2.2 Power Supply Units.- Each equipment element for which redundancy has been provided shall operate from its own power supply unit, so that any single power supply failure shall not make inoperative more than one equipment element. In addition, if the central computer complex operates from motor-generator AC power sources, these motor-generators shall be supplied with sufficient redundancy so that each unit can be serviced off line without reducing the maximum required CCC capacity.

3.2.3 Radio-Frequency Interference.- The CCC equipment shall satisfy the basic limits of interference and susceptibility as specified in 4.3.2, 4.3.4.1.1, 4.3.4.1.2, and 4.3.4.2 of MLL-I-26600 (USAF) and Amendment 2 thereto. The contractor should note that the prospective locale for each CCC installation will be one that is subject to large amounts of radiated or conducted electrical interference energy. The CCC equipment shall function satisfactorily under existing conditions at such a locale. Sources for the electrical interference include radars, communication equipment, display equipment, teletypewriter equipment, and similar devices.

3.3 Data Processing Functions, Organization, and Loads.- Three sizes of CCC system configurations are described herein. This section and the referenced tables specify the criteria for arriving at an organization and system size suited to the three configurations specified in 3.5.1, 3.5.2, and 3.5.3.

3.3.1 Introduction.- The data processing requirements for each configuration are stated by specifying:

- (a) The time interval within which all functions comprising the total processing task must be performed; and
- (b) The storage, input/output transfers, and computing time associated with the functions.

The operational air traffic control functions comprising the total data processing task are divided into three areas as follows (See Appendix E for further details):

(a) Flight Plan Data Processing Area -

- (1) Controller Inputs
- (2) Alphanumeric Inputs
- (3) Fix-time Determination
- (4) Flight Plan Dynamics
- (5) Conflict Detection
- (6) Association Checking
- (7) Flow Control

(b) Surveillance Data Processing Area -

- (1) Radar Input Processing
- (2) Automatic Tracking
- (3) Proximity Warning

(c) Output Data Processing Area -

- (1) Plan-Position Display Generation
- (2) Tabular Display Generation
- (3) On-Demand Printer Outputs
- (4) Automatic Printer Outputs
- (5) Inter-facility Outputs

The maximum cycle time (time within which all functions are performed) of the system shall be 2.5 seconds. This cyclic operation shall be continuous. The storage, input/output transfers, and computing time requirements associated with the above functions are presented in the tables of Appendices B, C, and D in terms of an experimental system. This experimental system is one that has been operated by the Mitre Corporation at Bedford, Massachusetts, under Contract No. FAA/ARDS-497.

3.3.2 System Organization Requirements.- Because a detailed organization of the data processing task is dependent on equipment characteristics, this section specifies only the general characteristics of the system organization and the associated requirements. A data processing organization shall be determined for each system configuration required which is suited to the capabilities of the particular CCC elements. The organization must account for the impact of program, table, and I/O data transfers on the cycle time. The data input and output, storage, and computing time requirements stated in terms of the experimental system in Appendices B, C, and D are to be translated into load requirements for the CCC configuration.

3.3.2.1 Storage Tradeoffs.- The amount of primary storage required for the total processing task depends mainly on two factors. One is the characteristics of the bulk storage that is part of the CCC--its access time and transfer rate. The second factor is the characteristics and capability of the input/output (I/O) elements. Within the limitations imposed by the environmental requirements of the data processing functions, i.e., the data input and output transfers and the program and table transfers, trade-offs exist among the required size of primary storage, the amount and characteristics of bulk storage, and the I/O capacity of the CCC. The best solution depends on the hardware characteristics of the CCC equipment elements and the technique used for external peripheral data handling (3.4).

3.3.2.2 Inputting and Outputting.- All data channels that input information to the CCC or output information from the CCC shall be connected via multiplexers or buffers, or both (peripheral-device adapters) with the system peripheral devices. Most input and output data may be batch processed. Input data batches may be accumulated in buffers external to the CCC, in primary storage tables within the CCC, or in some combination of the two. Similarly, output data batches may be block transferred to external buffers, held in primary storage and metered out to peripheral devices at the appropriate rate, or handled in some combination.

3.3.2.3 Data Flow.- The flow of data through a typical system is summarized in the flow chart of Figure 3.2. All significant interactions have been shown. Functions have been segregated into four areas: flight plan data processing, surveillance data processing, output data processing, and executive control. Program functions are represented by single boxes while tables are represented by double boxes. Static and dynamic tables associated with the flight plan and surveillance data processing areas are the only ones shown. Tables in Appendices B, C, and D indicate the size of these tables and also the additional working tables required for each function.

3.3.2.4 Conditional Operations.- Certain functions, indicated by an asterisk on Figure 3.2, need be operated only conditionally on the occurrence of some previous event. For example, alphanumeric keyboard input processing need not be performed unless there are inputs to be processed. Nevertheless, for the purpose of determining data processing requirements, all functions shall be assumed to be operated every cycle. (The loads shown

by Appendices B, C, and D for conditional operations has already been prorated to permit this.) Handling of conditional operations rests with the executive control function and whatever special features, such as interrupts, that the particular CCC equipment provides.

3.3.2.5 Sequence of Functions.- The sequence used by the experimental system for performing functions comprising the data processing task are indicated by the sequence of functions from left to right on Figure 3.2. Note that no particular sequence is implied in the output area. Certain functions of the flight plan area, e.g., association checking, are not considered sequence critical, and hence are indicated below the main line of flight plan functions. The sequences indicated by Figure 3.2 minimize the time between input and output when a number of functions are involved and insure that the most recent data available to the system is utilized for the outputs. To illustrate the effect of the sequence in the flight plan area, considered the case where a controller requests a conflict probe for a particular flight plan. The Controller Inputs function detects this action and sets the appropriate indicators so that the Conflict Detection function will probe the flight. However, the Conflict Detection function will not operate until after Flight Plan Dynamics so that the most recently updated flight plan data is utilized. The flight plan data base may be updated by either Controller Inputs or Alphanumeric Inputs. Consequently, both these functions are operated before Flight Plan Dynamics. After Conflict Detection operates, the results of the conflict probe are communicated to the operator through the appropriate Data Output function and associated output device. All functions are performed every cycle.

3.3.2.6 Operation at Reduced Demand.- When the traffic demand decreases below 50 percent of peak capacity, the CCC will be operated in the low traffic demand level described in 3.6.1.1. No requirement exists that the same data processing organization or table structure that services the peak-demand level also service the low-demand level. It may be assumed that a different data processing organization--specifically tailored to accommodate only this reduced demand--will be operative during these periods. It may be convenient to assume also that different master program routines service each mode of operation.

3.3.3 Storage, Input/Output, and Computing Time Requirements.- All data provided in the tabulations included in Appendices B, C, and D are based on the experience gained from the design and operation of the experimental system. The data processor of this experimental system is capable of performing the total processing task only for relatively low traffic demand. The characteristics of this processor are stated in 4. of Appendix A. This data must be scaled in accordance with the characteristics of the particular CCC configuration to show compliance with the stated system capacity and cycle time requirements. Tables B-1a, b, c, B-2a, b, c, and B-3a, b, c of Appendix B, for example, show, as a function of load, the common table and program routine structure existing for the listed functions of the configuration for 325 flights (3.5.1). The data is presented in this form to permit consideration of a data processing organization which would permit a decrease in the

primary storage requirement at the expense of increased communication between primary and bulk storage. Each table is divided into three parts--a, b, and c, for the functions of the flight plan or input, surveillance, and output data processing areas. Requirements for the executive control area will be based upon a particular data processing organization and are to be associated directly with the operational functions and related I/O operations.

AP is a table structure

3.3.3.1 Table Storage.- Except in large primary storage machines, it will not be possible to set up in primary storage the complete table environment for the most demanding functions. It is valid to assume that any function may be processed in as many passes as are desirable to accommodate the required table structure. To facilitate such a breakdown, data is presented as a function of flight load. The total flight load may be broken into as many parts as is convenient. However, this approach requires an I/O capability which will guarantee that the proper tables are available in primary storage when needed, without violating the 2.5-second cycle requirement.

3.4 Peripheral Data Buffer Approach

3.4.1 Peripheral-Device Adapters.- Peripheral-device adapters shall be provided for each CCC configuration to input and output data between the computer I/O channel and the external peripheral devices, except for the peripheral-device adapters required for the plan-position and tabular display devices (Figure 3-1). The experimental system utilizes a hardware complex in which all input and output data batches are buffered externally on drums, with all peripheral devices connected to this external drum system (Appendix A). Since the data processing requirements of the CCC are based on an analysis of the same experimental system, the peripheral data storage and I/O transfer requirements have been stated (Appendices B, C, and D) in terms of this particular hardware solution to the peripheral data storage and transfer problem. Reference to tables in these appendices gives the amount of data that will be sent to the displays. For the 325-flight configuration, there will be from 20 to 30 plan-position displays and an equal number of tabular displays. For the 200-flight configuration, the number of each type display is the same as for the 325-flight configuration, and for the 100-flight configuration, up to 20 plan-position and tabular displays may be used.

3.4.1.1 Alternative to Buffering on Drums.- So that alternative solutions to the peripheral data storage and transfer problem can be considered, Tables B-4, C-4, and D-4 summarize the number and data characteristics of individual external devices by type for each required configuration. The plan-position and tabular displays are excluded from this summary since any peripheral-device adapters (for buffering, formatting, and similar functions), if required, between the computer I/O channel and the displays are not a part of this specification. The contractor shall, however, provide sufficient I/O elements and adjunct data channels (if required) to drive all plan-position and tabular displays.

3.4.2 Interface of CCC Equipment with External Peripheral Equipment.- The processed digital radar data will be inputted to a peripheral-device adapter by a radar video data processor (RVDP) currently being procured. The RVDP

output interface has not been totally specified, however, the logic levels and impedance characteristics are determined. The output data format of the RVDP will be either 12 bits plus one parity bit, or 6 bits plus one parity bit, transmitted in parallel. The CCC shall be designed to accommodate either format, but not both. The CCC shall accept data from some RVDP's at a maximum equivalent serial bit rate of 2400 bits-per-second on each of three data lines, and from other RVDP's at 7200 bits-per-second on one data line. In the case of three 2400-bits-per-second lines, each line carries discrete messages. The CCC input shall handle up to 15 such RVDP units, with provision for later expansion up to 18. The remaining interfaces to peripheral equipments consisting of controller input devices, alphanumeric keyboards, input and output inter-facility teletypewriter or digital data links, high-speed printers, and on-demand printers (such as teletypewriters) have not been defined. The data rates for these peripheral devices for each CCC configuration are shown in Tables B-4, C-4, and D-4 in the appendices. The contractor shall be responsible for designing the detailed CCC interface with the peripheral equipments in conjunction with the FAA Contracting Officer's Technical Representative and the peripheral equipment manufacturers. The contractor shall furnish detailed interface design and data in accordance with 3.11.5.

3.4.3 Additional Data Buffer Requirements.- The number and types of external devices for the particular configuration (3.5.1, 3.5.2, and 3.5.3) are assumed to be constant irrespective of traffic load, hence all requirements for input buffer storage are treated as being independent of the aircraft load, n. Except for inter-facility outputs, all requirements for output buffer storage are proportional to traffic load.

3.4.3.1 Since each function will be executed only once per cycle, every solution to the peripheral data buffer problem must provide for the maximum amount of information listed in Tables B-4, C-4, and D-4, whether this storage is provided internally in primary memory, externally on drums or other storage media, or in some combination.

3.4.3.2 Information storage may be only a part of the total buffer storage required. The characteristics of a proposed buffer system and related logic may require additional storage for data used to control the addressing and timing of outputs, and to tag the source of input data on less than a complete message basis. For example, the drum buffering subsystem of the experimental ATC system allows for storage of four 6-bit information characters of high-speed and on-demand printer outputs for each 32-bit computer word. Provisions shall be made for storing the overhead data as well as information data in any solution to the peripheral data storage and transfer problem.

3.4.3.3 The entries in Tables B-1a, b, c, C-1a, b, c, and D-1a, b, for peripheral data storage associated with any function is the sum of the maximum amount of information required to be buffered during a 2.5-second cycle (from Tables B-4, C-4, D-4) and the overhead data associated with that information. In addition, since Tables B-2a, b, c, C-2a, b, c, and D-2a, b, are based upon an approach to buffering where all inputs are entirely externally buffered, the entry for Mandatory Transfers--Peripheral Data associated with any function is also the sum of the maximum amount of information required to be buffered during a 2.5-second cycle (from Tables B-4, C-4, and D-4) and the

overhead data associated with that information. For outputs, and for inputs in the case where inputs are internally buffered, the Mandatory Transfers-- Peripheral Data entry of Tables B-2a, b, c, C-2a, b, c, and D-2a, b would be the average amount of information plus associated overhead data transmitted for each type of input or output during each 2.5-second cycle.

3.5 System Configuration Requirements.- Three complete and separate CCC system configurations are specified in the following paragraphs. Each configuration shall handle the specified functions and processing load with the minimum quantity of equipment that meets the required redundancy and reliability requirements. Note that the three system configurations are to be such as to facilitate transitions from the smaller to the larger and thus permit subsequent FAA programs to progressively implement functions and loading at a given location.

3.5.1 Configuration for 325 Flights.- A CCC configuration shall be furnished which provides for data processing in accordance with functions and loading specified by Tables B-1a, b, c, B-2a, b, c, and B-3a, b, c, and for the external peripheral devices specified by Table B-4. This configuration shall handle 325 flights ($n = 325$ in the data processing tables) and the functions indicated by the tables. The CCC equipment shall include all required peripheral-device adapters to input and output data between the computer I/O channel and the external peripheral devices described by Table B-4, except for the peripheral-device adapters required for the plan-position and tabular displays. The computer-oriented peripheral devices called for in 3.2.1.9 shall also be provided.

3.5.2 Configuration for 200 Flights.- This is a scaled-down version of the 325 flight configuration. A CCC configuration shall be furnished which provides for data processing in accordance with functions and loading specified by Tables C-1a, b, c, C-2a, b, c, and C-3a, b, c, and for the external peripheral devices specified by Table C-4. This configuration shall handle 200 flights ($n = 200$ in the data processing charts) and the functions indicated by the tables. The CCC equipment shall include all required peripheral-device adapters to input and output data between the computer I/O channel and the external peripheral devices described by Table C-4, except for the peripheral-device adapters required for the plan-position and tabular displays. The computer-oriented peripheral devices called for in 3.2.1.9 shall also be provided.

3.5.3 Configuration for 100 Flights.- This shall be a minimum configuration system consisting of a reduced version of the 200-flight configuration. It shall perform the radar/radar-beacon tracking function for 100 simultaneous tracks with inputs from four radars, and provide 100 alphanumeric tags in association with video on a plan-position display. This CCC configuration shall provide for data processing in accordance with functions and loading specified by Tables D-2, b, D-2a, b, and D-3a, b, and for the external peripheral device specified by Table D-4. This configuration shall handle 100 flights ($n = 100$ in the data processing tables), and the functions indicated by the tables. The CCC equipment shall include all required

peripheral-device adapters to input and output data between the computer I/O channels and the external peripheral devices described by Table D-4, except for the peripheral-device adapters required for the plan-position and tabular displays. The computer-oriented peripheral devices called for in 3.2.1.9 shall also be provided. This CCC configuration shall incorporate sufficient hardware to perform the required functions, at the specified load of 100 flights, using conventional programming techniques and available software.

3.6 Reliability

3.6.1 Introduction.- The CCC shall provide functional operation seven days a week, with an absolute minimum of scheduled and non-scheduled down time. In the case of progressive failures that continuously reduce the number of hardware elements that are available under program control, the CCC shall at first "fail-safely" by using redundant elements; i.e., no functions are to be discontinued nor is the rate at which these functions are performed changed (operation unaffected by an element failure by virtue of activation of a redundant element). As failures continue, and the number of CCC elements available are less than that needed to maintain a fail-safe condition, the complex shall "fail-softly" by first extending the time interval for selected functions (functions chosen to result in no loss of input data) and second, discontinue some functions. In discontinuing functions, the more sophisticated programs (advanced planning, sequencing, etc.) would be dropped first and basic information last (e.g., alphanumerics on beacon targets). The objective of continuous operation with an absolute minimum of scheduled and non-scheduled down time shall be achieved by:

- X { (a) Redundant capacity for all hardware elements, together with automatic error and failure detection, and dynamic system recovery capability through activation of the redundant elements. *RP*
Amudo
- (b) Automatic adjustments in the scheduling of data processing loads and functions for the CCC elements when failures occur. The available data-processing capacity shall be applied to the load requirements so that a reduction in rate or of functions does not occur while excess capacity is available in the CCC.

This latter feature permits the CCC to maintain performance during light traffic demand periods even though element failure occurs after all redundant elements are in use. It also permits the CCC to maintain limited performance, at the expense of dropping some functional capability, when more severe failures occur.

3.6.1.1 Diurnal Load Variations.- The daily traffic demand on the CCC varies approximately according to the following rates:

- (a) High, 80 to 100% of peak capacity for 5 hr/day (several hours in the morning and several in the late afternoon).

- (b) Medium, 50 to 80% of peak capacity for 7 hr/day.
- (c) Low, 0 to 50% of peak capacity for 12 hr/day.

3.6.2 Reliability Definitions

3.6.2.1 Modes of Operation.- The "Mode" of operation describes the status of CCC system capability with respect to the functional and traffic demand capacity.

- (a) Mode A1 is defined as the condition when 100% traffic demand capacity and 100% functional capability exists;
- (b) Mode B1 is defined as the condition when failure has reduced the CCC capacity to 80% of peak traffic demand, and full functional capability still exists; and
- (c) Mode C1 is the same as Mode B1 except that the CCC capacity is reduced to 50% of peak traffic demand; a full functional capability still exists.

Mode designations using a numeric of 2 or above (A2, B3, C2, etc.) indicate lower modes for which the full functional capability does not exist, the degree of degradation rising as the number increases. For purposes of simplifying these requirements, only the A1 and C1 reliability figures will be specified; this is not to be construed as lessening the implied reliability requirements at intermediate levels of traffic demand.

3.6.2.2 Mode Failure.- Mode failure is defined as the failure of an active CCC element which causes a shift in mode of operation to a lower mode.

3.6.2.3 Mode Change.- Mode change is defined as any change in traffic demand or element availability which causes the CCC to increase or decrease the air traffic control functions being processed or change the rate at which they are being processed.

3.6.2.4 Active Element.- Active elements are those equipment elements (e.g., memory, computing, I/O or peripheral-device adapter) required to service the data processing load of any given mode.

3.6.2.5 Redundant Element.- Redundant elements are those equipment elements which are required to provide excess capacity for reliability, and when operable, are available for program assignment.

3.6.2.6 Transient Failure.- Two classes of transient failure are defined:

- (a) Self-clearing transient disturbances, such as transient parity errors, which do not require deactivation of an active element; and

- (b) Non-clearing failures of an active element requiring deactivation of this element and its replacement by a redundant element, if available.

3.6.2.7 Mean Down Time--Mean Up Time

- (a) Mean Down Time (MDT) is the mean of the times required to re-establish the desired mode of operation of the CCC after it has had a mode failure. Failure of any equipment within the CCC bounds (3.1.2) shall be taken into account in the computation of MDT, provided it is the cause of the mode failure or prolongs a mode failure initiated by some other element.
- (b) Mean Up Time (MUT) is the mean of the times between mode failures, minus the MDT.

3.6.3 Detailed Reliability Requirements

3.6.3.1 Detection of Element Failure and Dynamic Activation or Deactivation of Elements and Functions According to Failures and Traffic Demand

- (a) The CCC shall provide redundant capability for all hardware elements in the form of additional elements over and above the number required for full load, full functional operation;
- (b) The CCC shall automatically detect failure, errors, and malfunctions in an element, dynamically deactivate a defective element, and activate a redundant normal element when operating with appropriate software. (Such software is not a deliverable item under this specification). The techniques used to accomplish this automatic detection and element activation/deactivation may utilize both hardware logic and programming; however, the hardware design shall not impose an excessive burden on the programming effort in order to realize these automatic features;
- (c) When elements fail in excess of those available for redundancy (i.e., all redundant elements of this type are being fully used and none are available for replacement) but the traffic demand is low enough that there is sufficient excess capacity available in some elements that have not failed, the CCC system shall deactivate the defective element/elements and redistribute its assignment of functions so that no loss of function occurs when operating with appropriate software. (Such software is not a deliverable item under this specification.) Note that whenever the CCC's effective overall capacity is marginal or insufficient to handle the current demand and functions, due to some defective element, the functional capability shall degrade and not the traffic load capability;

- (d) When elements fail in excess of those available for redundancy, and the traffic demand is such that insufficient capacity is available in the remaining elements, the CCC system shall deactivate the defective element/elements and automatically degrade or drop out functional capability, according to a predetermined schedule of functional priority when operating with appropriate software. (Such software is not a deliverable item under this specification.) The CCC shall not reduce its traffic load capacity; i.e., data and reports from all aircraft shall be processed and no data shall be lost. As traffic demand varies under this condition, the functional capability shall increase or decrease as required to maintain full current traffic demand capability;
- (e) Elements that are redundant shall be available for non-operational uses such as program check-outs, data reduction, and statistical analysis. However, this usage shall not affect the operating program, and shall not prohibit these redundant elements from being automatically brought into active operation; and
- (f) The reconfiguration function described in (b), (c), and (d) above shall be accomplished without manual intervention.

3.6.3.2 Reconfiguration Time After Failures.- The following applies when operating with appropriate software. (Such software is not a deliverable item under this specification.)

not in AP

- (a) For a non-clearing transient failure (i.e., an active element has failed) where a redundant element is available to replace the failed element, the CCC shall automatically reconfigure, replacing the failed element with the redundant one, within 30 seconds after the transient failure.
- (b) Transition from any mode to a lower mode resulting from mode failure shall be accomplished within 30 seconds after a mode failure.

3.6.3.3 Reliability for Mode A1.- The CCC shall have a MUT of 1000 hours or greater when operating in the A1 mode (3.6.2.1). The CCC shall have a MDT of 1 hour or less when operating in the A1 mode. These requirements, as well as those of 3.6.3.4, shall be met using the contractor's recommended maintenance staff and maintenance programs, and shall conform to maintenance services specified under 3.8.3; test equipment used shall be limited to that furnished the Government as part of the basic CCC contract (3.8.3.4).

3.6.3.4 Reliability for Mode C1.- Except for the 100-flight configuration (3.5.3), the CCC shall have a MUT of 10,000 hours or greater when operating in the C1 mode, and a MDT of 0.5-hour or less.

3.6.3.5 Mean Time Between Failure.- The mean time between non-clearing transient failures (3.6.2.6) involving the failure of an active element when a redundant element is available to replace the failed element shall exceed 12 hours.

3.6.3.6 Application of Reliability Requirements to the 325, 200, and 100 Flight Load CCC Configurations.- The requirements of 3.6 and its subparagraphs shall apply to all three CCC configurations, subject only to the provisions applicable to the 100-flight configuration appearing in 3.2 and 3.6.3.4.

3.7 Software Support

3.7.1 Utility System.- A complete set of utility programs must be provided. The following programs are a minimum requirement.

3.7.1.1 Assembler.- A working assembler designed for, capable of running on, and producing machine code for the CCC from input symbolic machine-oriented source statements, is required as a minimum programming aid for developing programs to perform the complex real-time functions described in this specification. The object code shall be either relocatable or absolute for any given translation. The translation shall, in general, convert one source statement into one machine-coded instruction or value word. Translator control source statements shall be available to handle decimal to binary conversions, acceptance of alphabetical data, storage allocation, input-output, translation and control, and control of documentation. A comool feature is desirable with the assembler.

3.7.1.2 Loaders.- These programs must be capable of loading object programs produced by the assembler, data from magnetic tape, alphanumeric keyboard, or card reader into primary and bulk storage. The loader programs shall be self loading. It is desirable that object programs be callable from a library under program control.

3.7.1.3 Dumps.- Programs shall be supplied for transferring the contents of bulk and primary storage in octal, decimal, or mnemonic instruction code to magnetic tape plus card punch or high-speed printer.

3.7.1.4 Program Debugging Aids.- These programs shall include full and selective program tracing and break-point testing routines as a minimum.

3.7.1.5 Delivery of Software.- The software for the utility system shall be delivered in operational condition six months from date of contract. The delivered items shall include an operational utility system contained on magnetic tape, and a symbolic program deck and listing.

3.7.1.6 High-Order Language.- The provision of a high-order language or compiler is desired but not required as part of this procurement. If such a language is available and is to be included as part of the CCC software package, a descriptive programmer reference manual shall be included with the technical proposal.

3.7.1.7 Utility System Software Documentation.- Each piece of software shall be documented, both for programmer and operator usage, and for maintenance and modification of the software.

3.7.1.7.1 Assembler Reference Manual.- An assembler reference manual shall be provided and shall describe all actions required to prepare source language statements, initiate assembly, and analyze resulting listings as to encountered error conditions. The reference manual shall be written to conform to good commercial practice and contain sufficient detail to enable programmers to produce computer programs without referencing additional documentation.

3.7.1.7.2 Assembler Operator's Manual.- An assembler operator's manual shall be provided and shall include initiation and intervention procedures, a complete list of possible error halts, and all possible actions required of the operator.

3.7.1.7.3 Utility System Specifications.- Detailed specifications shall be provided, including appropriate flow diagrams and instructions to permit operation, maintenance, and program modifications for the assembler, loaders, dumps, and the program debugging aids.

3.7.1.7.4 Delivery.- Two hundred copies of utility system software documentation shall be delivered to the COTR in accordance with the following:

- (a) Assembler reference manual, one month after date of contract;
- (b) Assembler operator's manual, six months after date of contract;
- (c) Specification, assembler, six months after date of contract;
- (d) Specification, loaders, six months after date of contract;
- (e) Specification, dumps, six months after date of contract; and
- (f) Specification, program debugging aids, six months after date of contract.

3.7.2 Programmer's Reference Manual.- The contractor shall furnish 200 copies of a programmer's reference manual to the COTR one month after date of contract; it shall include a description of the computer instructions, commands, and orders used in an operational machine program. The manual shall also include but not be limited to information on instruction timing, single and double precision operations, use of index registers, logical and arithmetic operations, data transmission, I/O operation, use of indicator lights and branch switches, and data necessary for the use and control of the computing machine. The manual shall be prepared in a careful and workmanlike manner in accordance with best practices (consistent with the intended use) as applied to similar manuals normally furnished for commercial equipment. It is intended that a contractor's standard commercial manual,

if suitable, be furnished, with supplemental material as necessary furnished as an addendum to the standard manual or provided as a supplemental or separate volume.

3.7.3 Maintenance Programs.- A maintenance system containing software providing for continuing operation of the CCC and satisfying the requirements contained in this specification must be supplied (see 3.8.3 in association with the following software descriptions.)

*Continuous
to ASPRC*

3.7.3.1 Off-Line Maintenance Programs.- Programs and applicable documentation shall be provided as specified below. These programs will be utilized off line to test, detect, and isolate errors within basic CCC modules. These programs must be capable of isolating faults to a logic section within a basic CCC element (e.g., failure of bit 10 of word 4010 in memory module B). The computer utilizing a suitable output device of the CCC will output the resulting diagnosis in an applicable form for use by maintenance personnel.

3.7.3.1.1 Off-Line Maintenance Program Delivery.- Three complete sets of documentation shall be provided six months after date of contract, and shall include initiation and intervention procedures, a complete list of possible error halts, and all possible actions required of the operator. Fifty additional copies of this documentation shall be supplied at the time of delivery of the CCC. The program itself shall be provided at the time of delivery of the CCC contained on magnetic tape and on a symbolic program deck with appropriate listing.

3.7.3.2 On-Line Maintenance Programs.- Programs to operate with the operational system which are designed to maintain continuous operation are required and will include:

- (a) Confidence routine ✓
- (b) Operational diagnostic ✓
- (c) Data correction and recovery ✓
- (d) Reconfiguration and mode control ✗

Such programs are not a deliverable item under this specification, however, they are further defined in section 3.8.

3.8 System Maintenance Requirements

3.8.1 Scope.- The CCC shall operate with a minimum of down time and a minimum of human involvement. Proven or existing equipment and techniques shall be used to the greatest extent possible. Below are those hardware, software, and test implementation requirements, and desirable features that support this design.

3.8.2 Maintenance Definitions

3.8.2.1 Element Status.- In order to state the requirements of the NAS 300 Maintenance System, it is necessary to define elements by their current status in the system. Equipment status has been broken down into the following categories. Their definitions follow:

3.8.2.1.1 Active Elements.- Active elements are defined by 3.6.2.4.

3.8.2.1.2 Redundant Elements

- 100 %
- (a) On-Line Redundant.- Those hardware elements not presently being used to perform an ATC function, but which would be available for use by the operational system within the 30-second recovery period permitted by 3.6.3.2.
 - (b) Off-Line Redundant.- Those hardware elements not presently being used to perform an ATC function and which would not be available for use by the operational ATC system within the 30-second recovery period specified in 3.6.3.2. These elements would probably be used to perform an off-line function such as scheduled or unscheduled maintenance. It is likely that manual intervention would be required to place these elements on-line, with the actual time before these elements could be available to the on-line system depending upon the hardware configuration chosen. It would be desirable for all elements in operational condition to be available automatically to the operational ATC system within the 30-second transient recovery period mentioned above-- regardless of their current use--in which case the category being discussed here would not exist.
 - (c) Inactive.- Those hardware elements that are not available to the operational system within the near future. Typical reasons for non-availability might be due to component failure, marginal checking (preventive maintenance), and element power off.

3.8.2.2 Types of Maintenance.- The maintenance function will be classified as either "on-line" or "off-line." On-line maintenance would be performed only on on-line elements. Off-line maintenance would generally be performed only on off-line elements. In a hardware configuration where all elements (except failed elements) would be available within a 30-second recovery period, the off-line maintenance function, as defined here, might be run on a combination of on-line and off-line elements.

3.8.2.2.1 On-Line Maintenance.- Although maintenance is generally considered as an off-line function, being performed on off-line elements, certain operational (software) functions are defined herein as on-line maintenance. These software functions include programs to maintain and report on current

element status, to detect errors, and to diagnose and print out limited information on errors for maintenance personnel (3.8.3.3).

3.8.2.2.2 Off-Line Maintenance.- The bulk of the maintenance function would generally be performed on off-line elements. Off-line maintenance is generally classified as either scheduled maintenance or unscheduled maintenance. A further breakdown follows.

3.8.2.2.2.1 Scheduled Maintenance.- Scheduled maintenance includes preventive types of maintenance, routine maintenance, and corrective maintenance.

- (a) Preventive Maintenance.- Preventive maintenance is defined as planned periodic marginal and functional testing of the CCC elements and components. Preventive maintenance techniques (e.g., voltage or clock timing marginal checks) are chosen so as to detect marginal components (e.g., due to aging or drift) and system misalignment (e.g., non-optimum settings of tape system head gains).
- (b) Routine Maintenance.- Routine maintenance consists of the regular repair of failed components at the test bench and regular repair or maintenance of mechanical and electro-mechanical devices (e.g., clean tape heads and loop boxes or vacuum air filters).
- (c) Corrective Maintenance of Known Failures.- Corrective maintenance on failed CCC elements can often be scheduled for a later work shift where a higher maintenance capability would exist or at a time when there is a low traffic demand. During periods of low traffic demand, additional elements would be available to aid in the repair and test of the failed element. Such maintenance is classified as scheduled corrective maintenance.

3.8.2.2.2.2 Unscheduled Maintenance.- Unscheduled maintenance consists of maintenance required immediately following a failure found by the on-line maintenance function and which can not be scheduled for a later time (e.g., total system failure, or element failure where no further redundant element of that type remains for use by the operational system). Normally, single element failures occurring during peak traffic loads would be scheduled for repair during a low-load period (i.e., scheduled corrective maintenance) or handled by off-line test equipment (3.8.3.4).

3.8.3 Maintenance Requirements.- These paragraphs specify maintenance requirements and reference other pertinent sections. Desirable features of a maintenance approach are discussed first.

3.8.3.1 Maintenance Approach.- The detailed maintenance approach for the complete CCC will depend upon the final equipment configuration as well as the chosen design options.

3.8.3.1.1 On-Line Maintenance.- When operating with appropriate software (not a deliverable item under this specification), the on-line maintenance function shall detect element failures. If an element failure is detected, the on-line maintenance function shall cause the equipment complex to be automatically reconfigured to exclude the failed element from further use by the cycling program complex. A redundant on-line element is then automatically assigned the tasks of the failed element. No manual intervention of any kind shall be required. If no redundant element exists (because of prior element failures), the fail-soft approach applies. In any case, appropriate notification to the maintenance personnel shall be generated.

3.8.3.1.2 Repair of Failed Element.- To effect the speedy repair of the failed element, necessitated by the reliability requirements in section 3.6, the following approaches or a combination of them are permissible:

- (a) Maintenance personnel may utilize special off-line test equipment exclusively;
- (b) If sufficient redundant elements are available, then a set of redundant elements may be taken off-line to form a test subsystem;
- (c) Depending on the equipment capability, a test subsystem may be defined that uses on-line redundant elements. However, in this case, it is mandatory that the redundant elements be available under program control to the active program complex in case of an element failure. It must further be assured that the program has the capability to completely lock out any manual controls and negate any special test parameters that maintenance personnel have set up in the redundant elements;
- (d) It may suffice to schedule repair of elements during low-load periods when sufficient redundant elements are available. The obvious penalty is increased down-time when an element fails during the high-load period.

3.8.3.1.3 Preventive Maintenance.- The requirement that the CCC operate 24 hours every day places severe restrictions on preventive maintenance. However, since the system load fluctuates in a predictable manner during each day, a carefully planned scheme of preventive maintenance can be conducted during low load conditions on redundant elements. If elements need be physically disconnected from the system it shall be accomplished without interference to the operational elements.

3.8.3.2 Hardware Features.- The hardware requirements of that portion of the system maintenance function which pertain to the actual CCC elements have been specified in section 3.2.1.10. In addition, all equipment shall provide that the process of taking elements off-line, operating elements off-line to form a test subsystem (including the on-off cycling of power, or returning elements on-line, does not generate any logical or electrical disturbances that might affect on-line system operation.

3.8.3.3 Maintenance Programs.- In line with the definitions of section 3.8.2, the maintenance programs can be grouped into two categories: on-line maintenance programs and off-line maintenance programs. A further breakdown follows.

3.8.3.3.1 On-Line Maintenance Programs.- These programs would perform the on-line maintenance functions described in 3.8.2.2.1 and might consist of the following:

- (a) Confidence Programs.- Such programs might consist of routines to perform simple tests on all on-line elements and report to the executive function on their status. The actual functions of these routines would depend upon both the hardware and software configurations. It is feasible to assume that quality control (e.g., radar return) routines might also be integrated into this function at some later date. These confidence programs would be cyclic in nature and might be performed during each system cycle;
- (b) Operational Diagnostic Program(s).- This diagnostic function would only be performed upon detection of an error by the confidence programs (discussed above) or ATC operational programs, or upon a hardware-initiated error interrupt. These operational diagnostic programs might collect data on or verify the failure, or both, output any pertinent information to an on-line printer (for use by maintenance personnel), and initiate corrective action;
- (c) Data Correction and Recovery Programs.- These would be "fix" type programs; i.e., correction of data after a failure. This corrective action might consist of a complete startover from safe data or simply a tape re-read. These programs are conditional and would only be performed when requested by the operational system. Useful information (to maintenance personnel) would be output to an on-line printer;
- (d) Reconfiguration and Mode Control Programs.- The reconfiguring of the on-line elements would be performed by the reconfiguration program which would also accept requests to reconfigure from the operational diagnostic function when a non-clearing operational element failure has been verified. The mode control program would, consist with the reliability requirements of section 3.6, change the mode of the CCC operation. Information on the reconfiguration or mode control process, or both, would be output to an on-line printer or maintenance console, or both.

An estimate of the storage and cycle time for these on-line maintenance routines shall be made and added to those required by the operational program as described elsewhere in this specification. Such on-line maintenance programs are not a deliverable item under this specification.

3.8.3.3.2 Off-Line Maintenance Programs.- These programs shall consist of a large number and variety of comprehensive maintenance programs. These programs shall include routines to test all CCC elements, including the computer-oriented peripheral devices and peripheral-device adapters. (The Government intends that routines to test and exercise the system-oriented peripheral devices also be integrated into this maintenance package at some later date, but not as a deliverable item under this specification.) A subset of these programs shall accomplish the preventive maintenance function discussed in 3.8.2.2.2.1 and 3.8.3.1.3. Because of its size, the total package may be stored on tape (drum or disc if feasible) with only a subset of the programs callable for use by the off-line maintenance function at any time. These programs may also be used, when possible, in the event of a total system failure. These programs include a diagnostic capability and should not be confused with the limited diagnostic capability of the operational diagnostics referred to in 3.8.3.3.1. The comprehensive maintenance programs discussed in this paragraph (3.8.3.3.2) shall diagnose failures and localize their precise source to the extent software techniques permit (e.g., failure of bit 10 of word 4010 of memory module B). All information pertinent to the failure shall be outputted to a printer or monitor/supervisory console, or both.

3.8.3.3.3 Deliverable Maintenance Software Items.- The comprehensive off-line maintenance programs discussed in 3.8.3.3.2 (deleting any system-oriented peripheral requirements) shall be supplied by the contractor. The on-line maintenance programs discussed in 3.7.3.2 and 3.8.3.3.1 will be integrated into the executive control program structure, but are not a deliverable item. As a minimum, the contractor shall show that his hardware configuration can perform the software functions described.

3.8.3.4 Off-Line Test Equipment.- In line with the general maintenance approach of 3.8.3.1, off-line test equipment shall be provided to meet the MDT requirements stated in section 3.6. The exact nature of this equipment will be dependent upon the proposed hardware configuration and cannot be described in detail at this time. The off-line test equipment shall isolate commonly encountered failures without the support of the redundant elements. It may not be possible to verify the correction of such failures during peak traffic loads because of the unavailability of redundant elements. When these inactive elements would be put back on-line would be dependent upon the type of failure, confidence in the failure correction, possible consequences to the operational ATC system if this element is not returned to an on-line status, and other factors.

3.8.4 Maintenance Services.- The contractor shall provide maintenance service for each system ordered for one year beginning within 90 days after preliminary acceptance, as ordered. The contractor shall provide all personnel and spare parts to maintain each CCC system on a 16-hour-a-day, 365-day-a-year basis to the level of performance and reliability required by this specification. Full system capability for full-load operation shall be available at least eight hours per day of the first shift. The medium-demand capability (50 - 80% of peak load, of 3.6.1.1) shall be available for the second eight hours per day. The contractor shall not use the remaining eight hours per day for routine, maintenance, but shall perform his routine services during the regular 16-hour operational period. If

maintenance beyond the 16-hour period is required in order to have the system "on-line" for the following day's operation, the contractor shall provide the maintenance as required at no additional charge to the Government.

3.8.4.1 Maintenance Log.- The contractor shall maintain a log of maintenance activities, outages, repairs, and spare parts used. Entries shall be reviewed and initiated by the Government's local technical representative. The contractor shall provide two copies of this log to the Government's local technical representative on a weekly basis. After six months operation, the contractor shall summarize the requirements for spare parts, based upon the maintenance log entries, and provide 15 copies of a recommended spare parts list to the Government for support of the system for the second year of operation, together with either approximate or firm prices for all items.

3.9 Installation.- The contractor shall install each system (3.5.1, 3.5.2, and 3.5.3) ordered at each site designated by the Government. All sites will be within the conterminous United States. Site preparation, including the furnishing and installation of any required air-conditioning, will be accomplished by the Government. The contractor shall provide the Government with two reproducibles and eight copies of all necessary site preparation specifications six months in advance of a proposed site installation. The contractor shall furnish all services, installation materials and personnel, equipment, including contractor-owned test equipment (except Government off-line test equipment in accordance with 3.8.3.4), and tools to install and debug the system. Installation and workmanship shall meet the standards of all national codes for this type of equipment. Upon completion of installation, preliminary acceptance tests shall be conducted by the contractor and witnessed by the Government in accordance with section 4. Preliminary acceptance of the system at the Government-designated site will be made after approval of all preliminary acceptance tests by the Government. Final acceptance of the system will be made after tests during the first year of operation which demonstrates MUT and MDT compliance; the reliability during the first year of operation following preliminary acceptance will provide the data for this determination. The first year of operation will be concurrent with the one year of maintenance service, section 3.8.4.

3.10 Design and Construction.- The overall design and construction shall be accomplished in a simple and straight-forward manner embodying the best engineering practices as applied to off-the-shelf equipment manufactured for a similar intended use. It is desirable that the equipment meet requirements of ER-D-406-010 or appropriate MIL specifications, or both.

3.11 Documentation.- The contractor shall provide all necessary services and material to develop and deliver documentation in accordance with requirements specified herein.

3.11.1 Program Planning and Control.- The contractor shall institute and maintain a Program Planning and Control System. This system shall be an SRDS NETWORK/MILESTONE presentation as described in Specification SRDS-1. As guidance, an FAA document, NETWORK/MILESTONE Techniques SRDS N/M-1, is recommended.

3.11.2 Documentation Contract Designation.- All documentation produced or updated by the contractor shall show the contract number conspicuously displayed on each document, including drawings, to facilitate identification and association with the contract.

3.11.3 Quality of Reproducibles.- All reproducibles furnished shall be of such quality as to permit the reproduction of every line and character on the reproduced copy. Reproducibles of the sepia type shall have a minimum background or field density (no burned or dark areas).

3.11.4 Contractor's Technical Reports.- The contractor shall furnish Type I Progress Reports in accordance with Specification SRDS-1 except as specified herein.

3.11.4.1 Type I Progress Reports.- Delete paragraph 3.2.1 of SRDS-1 and substitute the following:

3.2.1 Type I Progress Reports - The contractor shall prepare monthly Type I reports and submit ten copies to the FAA in accordance with Specification SRDS-1, 5.2. Preparation and submission of these reports shall commence the month following the date of contract and they shall be mailed no later than ten days following the reporting period. These reports shall include a concise statement of the work accomplished for the reporting period; summarize status of detailed design, fabrication, material orders and tests of any deliverable items; summarize meetings between the contractor and others participating in the program; discuss special problem areas, including solutions; and provide a brief statement of work planned for the next reporting period.

3.2.1.1 A planned work schedule for the contract shall be submitted in the form of an SRDS NETWORK/MILESTONE presentation. It shall include the delivery schedule of all deliverable items and shall be revised as necessary in each report. Any delays which may affect the contract delivery schedules shall be fully explained.

3.2.1.2 The front cover shall be of the same stock as used for the text, and shall include title, type of report, contract number, release date, and preparation block.

3.11.5 Design Data.- The scope and complex inter-relationship of FAA development programs require early knowledge of the contractor's design approach. Therefore, the contractor shall, within forty-five days of contract, provide ten copies of all data required hereunder to be submitted for design review, including the items specified in the subparagraphs below, to the FAA Contracting Officer's Technical Representative (COTR) for review and approval. The design data submission shall be organized to reflect the

contractor's approach to achieving compliance with the more significant requirements of the equipment specification. This submission of design data shall not be used by the contractor to propose modifications or alternates to details of the equipment specification or a change in scope of the contract. The design data referenced below shall include all elements of the equipment to be produced by the contractor under the terms of the contract, as detailed by the equipment specification and any addenda thereto, together with all interfaces with other equipment. A summary of equipment operational characteristics shall be included.

3.11.5.1 Block Diagrams.- A complete set of equipment block diagrams shall be provided by the contractor. The block diagrams shall show the general operational, electrical, and physical relationships of the equipment elements.

3.11.5.2 Information Logic Flow Diagrams.- The contractor shall provide complete information logic flow diagrams. These diagrams shall show the detailed logical, operational, and functional relationships of the equipment elements. Symbology used in these diagrams shall be fully explained in the basic document.

3.11.5.3 Input/Output Details.- The contractor shall provide a document which consolidates all CCC-boundary input/output characteristics. This document shall include, but not be restricted to electrical characteristics of inter-system cables, signal characteristics and limits, and timing diagrams. All external system interfaces shall be included.

3.11.5.4 Logic Diagrams.- Where logic circuits are proposed that are of unconventional design, the contractor shall provide logic diagrams and a summary of the particular design approach.

3.11.5.5 Detailed Physical Description.- The contractor shall provide a detailed physical description of the equipment. This description shall include: weights, outline drawings, configuration, layouts, ventilation or air-conditioning requirements, cable entry and exit features, clearance factors, power requirements, and other special details which should be considered for installation, operation, and maintenance of the equipment.

3.11.5.6 Design Review and Approval.- After receipt of the preliminary design, the FAA COTR shall review, and approve or direct any changes required in the design that are required to obtain conformity with this specification. The contractor shall change the design as necessary to conform with the requirements detailed by the FAA COTR and re-submit corrected revisions of the design data for approval within fifteen days after receipt of the design change requirements. In addition, the contractor shall, from time to time during the course of the contract, revise portions of the design data as directed by the FAA COTR or as deemed appropriate by the contractor, subject to the approval of the FAA COTR. The contractor shall provide two reproducibles and eight copies of all such revisions to the FAA COTR no later than fifteen days from the date of approval of the revision.

3.11.6 Index of Drawings and Technical Memoranda.- The contractor shall maintain an index of all drawings and technical memoranda produced in connection with design, fabrication, and test of the equipment. This index shall be updated monthly and two reproducibles and eight complete updated copies shall be submitted to the FAA COTR with the progress report (3.11.4.1). Drawings and technical memoranda produced in connection with the design and fabrication of off-the-shelf items which are in existence at the date of contract need be submitted only on a one-time basis with the first index. The contractor shall provide drawings or technical memoranda that may be requested by the contracting officer as listed by any index furnished in accordance with this requirement.

3.11.7 Installation Documents.- The contractor shall prepare and submit ten copies of documents containing all necessary information required by skilled technicians and engineers to correctly install the equipment and initiate its operation. These documents may be selected data prepared under other documentation requirements of the specification or previously prepared documents for installation of like equipment. Submission of these installation documents to the FAA COTR shall be made forty-five days prior to delivery of equipment.

3.11.8 Test Specification.- The contractor shall, ninety days prior to any equipment tests, submit for FAA review and approval a check list of recommended acceptance tests, descriptions, and data to be taken. FAA will review within thirty days. The contractor shall then prepare and submit two reproducibles and eight copies of a recommended test specification to the FAA COTR for review and approval thirty days prior to any equipment tests. The test specification shall conform to the FAA modified or approved check list, and be a comprehensive document including all details necessary to assure that test procedures and testing will satisfactorily demonstrate equipment compliance with all functional, environmental, electrical, mechanical, and reliability (other than MUT and MDT) requirements of the contract. The test specification shall provide a block diagram for the test configuration, a list of test equipment, and the machine programs which will be used, for the test. Although certain tests may be impracticable at the contractor's plant due to the unavailability of input data (real or simulated), the test specification shall be comprehensive and complete regardless of whether tests are to be conducted at the contractor's plant or elsewhere after installation. The contractor shall recommend and identify tests to be conducted at his plant and those he recommends be conducted elsewhere. Each test shall reference the specified requirement, including the paragraph number and any applicable tolerance, and other documentation for which the test is intended to demonstrate compliance. The contractor shall notify the FAA COTR of proposed test dates for recommended contractor-conducted tests in accordance with notification for inspection, 4.6. The Government shall have the right to require such additional testing as may be needed to show compliance with this specification.

3.11.9 Test Reports.- The contractor shall prepare and submit eight copies of recommended test data sheets to the FAA COTR for approval concurrently

with the recommended test specification. Test data sheets shall be complete with respect to all tests specified by the approved test specification, shall include the applicable test specification paragraph for each test, and shall identify tests recommended to be conducted at the contractor's plant and those to be conducted elsewhere. Two reproducibles and eight copies of the test data sheets as approved shall be submitted to the FAA COTR. The contractor shall conduct applicable tests according to the approved test specification, recording results of the tests of the approved test data sheets, and submit two reproducibles and eight copies of test reports, to the FAA COTR within thirty days after completion of tests.

3.11.10 Instruction Books.- The contractor shall furnish operation and maintenance manuals prepared in a careful and workmanlike manner in accordance with best practices (consistent with the intended use) as applied to similar manuals normally furnished for commercial equipment. It is intended that contractor standard commercial manuals, if suitable, be furnished, with supplemental material as necessary furnished as addenda to the standard manuals or provided as supplemental or separate volumes.

3.11.10.1 Contents.- Each equipment item, i.e., memory, I/O, computer, peripheral-device adapter, motor generator (if required), voltage regulator, power supply, and each type of computer-oriented peripheral equipment shall be documented for operation and maintenance of the equipment. As a minimum, these manuals shall include (as applicable to each configuration ordered): maintenance schedules and procedures, including test points, complete logical and timing diagrams, schematic diagrams, complete parts list, complete connection breakdown by pin, expected oscilloscope waveforms that describe normal operation of each unit, installation information required to correctly install the equipment and initiate its operation (including cabling and connection diagrams and applicable information).

3.11.10.1.1 Preparation and Delivery of Instruction Books.- Ten copies of initial instruction book manuscripts (commercial manuals, if suitable, plus addenda per 3.11.10) shall be submitted to the FAA COTR for review and approval sixty days prior to delivery of equipment. In addition to the books furnished and shipped with equipment (3.11.10.1.2), one reproducible (3.11.10.1.3) and 100 copies of the final books shall be furnished thirty days after approval of the manuscript books and shipped to approximately five addresses in the conterminous U.S. in accordance with shipping instructions to be furnished by the FAA COTR. Applicable corrections, additions, and deletions shall be made prior to printing of final books.

3.11.10.1.2 Instruction Book Delivery With Equipment.- One copy of the final instruction book for each unit of equipment shall be furnished and shipped with the equipment, except that the first unit of like equipments shall be accompanied by five copies.

3.11.10.1.3 Instruction Book Reproducibles.- The instruction book reproducible shall be on clean, white, smooth paper; drawings, photographs, or other artwork for illustrations shall be complete and ready for camera.

3.11.10.2 Programmer and Assembler Reference Manuals.- These manuals shall be furnished in accordance with software documentation requirements (section 3.7).

3.12 Cables.- The contractor shall furnish all intra- and inter-unit cables, with cable connectors, required for factory test and for installation and testing of the equipment, including any special-purpose test cables required for routine maintenance. Where patch panels or plug boards are used in the equipment, the contractor shall provide adequate plugs or patch cables required for normal equipment operation. Cables required for factory testing may be the same as those required for subsequent equipment installation and testing. Cables between peripheral-device adapters and system-oriented peripheral devices are not to be provided.

3.13 Cooperation and Coordination.- The contractor shall participate in meetings and conferences, and exchange technical data relating to the equipment performance and design compatibility with others as directed by the FAA COTR.

3.14 Service Conditions.- The equipment shall be designed to operate and maintain specified performance in accordance with indoor service conditions as follows:

- (a) Energy Source: single-phase, 2-wire, 120 volts $\pm 10\%$, or 3-phase, 4-wire, 120/200 volts $\pm 10\%$; 60-cps $\pm 2\%$ (steady state).
- (b) Elevation: up to 10,000 feet above sea level.
- (c) Duty: continuous, unattended.
- (d) Salt Atmosphere: as encountered in coastal regions.

3.15 Test Equipment and Tools.- The equipment shall be designed and fabricated so as to minimize any requirements for special test equipment and tools. Special test equipment and tools are defined as devices not readily available as commercial items.

3.16 Weight.- The total weight of the equipment shall be a minimum consistent with good design and economics. If possible, individual chassis of the equipment shall not exceed 40 lbs to facilitate maintenance handling. Construction of equipment racks or housing shall provide for even floor loading distribution not to exceed 200 lbs per square foot.

4. QUALITY ASSURANCE PROVISIONS

4.1 General.- The equipment shall be tested at the contractor's plant prior to equipment shipment (factory acceptance tests) and after installation at the Government designated site (preliminary acceptance tests),

in accordance with the approved test specification (3.11.8), and compliance therewith shall be demonstrated. All acceptance tests shall be performed by the contractor and witnessed by the FAA. However, the FAA reserves the right to waive witnessing of the complete inspection tests or any part thereof. If FAA witnessing of tests is waived, the contractor shall furnish certified test data showing the results of all such tests. In any case, factory acceptance by the FAA will not be made until test data, certified to be true and correct by a properly-authorized official of the company, and notarized, has been submitted and approved by the FAA.

4.2 Acceptance Tests

4.2.1 General.- The contractor shall perform factory acceptance and preliminary acceptance tests necessary to demonstrate that the equipment fully meets the requirements of this specification. The contractor shall furnish all test programs necessary to adequately test the CCC. Government-furnished equipment will not be provided for factory acceptance tests, except any deliverable items under the contract may be used.

4.2.2 Factory Acceptance Tests.- Factory acceptance tests shall be divided into four sections:

- (a) Quality Control Inspection
- (b) Functional Tests
- (c) Radio-Interference and Susceptibility Tests
- (d) Pre-Delivery Exercise

4.2.2.1 Quality Control Inspection.- This inspection shall include all checks and tests deemed necessary to ascertain that the equipment meets highest commercial standards and all applicable requirements of this and reference specifications.

4.2.2.2 Functional Tests.- The contractor shall demonstrate compliance with applicable sections of this specification. Tests shall consist of unit tests and integrated system tests.

4.2.2.3 Radio-Frequency Interference and Susceptibility Tests.- The contractor shall demonstrate that the equipment will satisfy the basic limits of interference and susceptibility tests as specified in 4.3.2, 4.3.4.1.1, 4.3.4.1.2, and 4.3.4.2 of MIL-I-26600 (USAF) and Amendment No. 2 thereto.

4.2.2.4 Factory Acceptance Exercise.- The CCC shall be exercised for a minimum period of 120 consecutive hours, meeting all specified requirements under existing ambient conditions of temperature and humidity. Maintenance schedules and allowable errors for this factory acceptance exercise will be determined when the check list of recommended test titles, descriptions,

and data to be taken (see 3.11.8) is submitted. During the factory acceptance exercise the CCC shall be operated at the upper workload limit of high capacity (3.6.1.1) for a minimum aggregate time of 12 hours per 24-hour period, and at the upper workload limit of medium capacity (3.6.1.1) for a minimum aggregate time of 6 hours per 24-hour period. The CCC shall be tested for a total of 6 hours with its power supplies adjusted for low margin voltage, 6 hours with its power supplies adjusted for high margin voltage, and for 6 hours with its power supplies adjusted so as to make the system most susceptible to electrical noise. The remainder of the 120-hour period shall be with its power supplies adjusted for normal voltage.

4.2.2.4.1 Test Routines.- The contractor shall prepare and debug adequate computer programs to exercise the equipment as described in 4.2.2.4 and collect the statistical information required in 4.2.2.4.3. These programs shall exercise all technical features of the equipment, all logic blocks, all computer commands, all data transfer channels, and all error checking circuits under worst case data conditions where known. All programs shall be supplied on magnetic tape and punched cards.

4.2.2.4.2 Reconfiguration Check.- A program shall be prepared, debugged and successfully run on the CCC to demonstrate reconfiguration. Recognizing that the final program for reconfiguration will be interwoven with the executive control and operational programs, the program prepared for this reconfiguration check need only demonstrate reconfiguration on the following simplified basis. As failures of elements are simulated, the program shall cause the CCC to "fail-safely", i.e., as elements fail they are deactivated and the program shall readjust the roles of the active and redundant elements so that operation is maintained at the same level as prior to the failure. As failed elements are returned to service, with suitable manual notification if required, the system shall return to normal system redundant/active element status. The Government inspector shall be able to drop or return elements at will during this test as long as two or more elements of the same type are not down simultaneously. Transition times shall be in accordance with 3.6.3.2. Additionally, as the failure of more than one element of the same type is simulated, the program shall provide an indication of the configuration status so that a status table of operable elements is available in shared memory at all times.

4.2.2.4.3 Error-Recording Routine.- An error-recording routine shall be provided which furnishes a printout of at least the following:

- (a) Running time of routine and running time to failure;
- (b) The routine in which the error occurred;
- (c) The instruction on which the error occurred; and
- (d) Contents of all registers.

For errors which do not set indicators advising monitoring personnel of each error, the following additional information will be required:

- (a) An indication of error with as much data as practical related to error type and source;
- (b) Data or results that should have been obtained on the erroneous data or performance actually obtained; and
- (c) Such other information as might be important for counting and evaluating errors.

4.2.2.4.4 Program Counter.- After each pass through each series of computer routines, the following printouts shall occur:

- (a) Pass number; and
- (b) Elapsed running time.

4.2.3 Preliminary Acceptance Tests.- Preliminary acceptance tests shall be conducted after installation (3.9) and consist of all or portions of tests specified by the test specification (3.11.8) or other tests as required to show compliance with specified requirements.

4.2.4 Test Program Documentation.- Each program which is used in the acceptance test shall be documented with the following information:

- (a) English language description of program and its purpose;
- (b) Symbolic listing of operating instructions;
- (c) Expected printouts under normal conditions and expected printouts under error conditions;
- (d) Flow chart; and
- (e) Running time.

4.2.4.1 Delivery.- Two reproducibles and eight copies of the test program documentation shall be delivered to the COTR thirty days prior to factory acceptance tests.

4.2.5 Software Acceptance Tests.- Software acceptance tests shall be conducted as part of the functional acceptance tests. However, the delivery of software shall be in accordance with schedules stated in section 3.7.

4.2.6 Test Records.- The contractor shall record complete and accurate information during the test on suitable data sheets or in log books, including the following information for each error:

- (a) Unit name and serial number;
- (b) Error number;
- (c) Date and time of error incidence;
- (d) Time of recovery;
- (e) Complete description of error; and
- (f) Type of error (detected or undetected).

4.3 Maintenance Records.- During pre-test debugging prior to and during factory and preliminary acceptance tests, a complete maintenance log which lists all malfunctions, their location in the system, and how they are repaired shall be kept. Odd situations, such as cases in which malfunctions disappear for reasons not clearly understood, shall also be recorded. Three copies of this record shall be furnished to the COTR at the completion of preliminary acceptance tests.

4.4 Test Equipment.- The contractor shall provide contractor-owned test equipment for contractor-performed factory and preliminary acceptance tests, except off-line test equipment to be provided in accordance with 3.8.3.4 may be used.

4.5 Inspection of Design and Fabrication Status.- Upon request from FAA, the contractor shall make available for review at his plant, at any stage of the contract, all information regarding the design and fabrication status of the equipment being manufactured to this specification.

4.6 Notification of Readiness for Inspection.- Notification of readiness for inspection shall be sent to the FAA Contracting Officer's Technical Representative at least ten days prior to the desired inspection start date.

4.7 Facilities for FAA Inspector.- When an FAA inspector is assigned for resident duty (two weeks or longer) at a contractor's or sub-contractor's plant, the contractor or sub-contractor shall provide the FAA inspector with a desk and file cabinet (with a lock on each), a typewriter, use of telephone (located at the desk) for official business in connection with the contract (cost of long-distance calls made by the inspector to be borne by FAA), and sufficient working space to permit him to perform his required duties adequately. Similar facilities shall be afforded inspectors assigned for periods of 1 to 13 days except that the file cabinet is not required.

5. PREPARATION FOR DELIVERY

5.1 General.- The contractor shall make all arrangements for shipment and delivery of the equipment and other contract items, FOB destination.

6. NOTES6.1 Appendices

Appendix A: Determination of Adjustment Factors for Computing Time, Program Length, and Data Length

Appendix B: Data Processing Tables for the 325 Flight Configuration

Table B-1a - Primary Storage Chart, Flight Plan Processing
Table B-1b - Primary Storage Chart, Surveillance Processing
Table B-1c - Primary Storage Chart, Output Processing
Table B-2a - Input/Output Transfers, Flight Plan Processing
Table B-2b - Input/Output Transfers, Surveillance Processing
Table B-2c - Input/Output Transfers, Output Processing
Table B-3a - Timing Data, Flight Plan Processing
Table B-3b - Timing Data, Surveillance Processing
Table B-3c - Timing Data, Output Processing
Table B-4 - Number and Characteristics of External Devices--325 Flight Configuration

Appendix C: Data Processing Tables for the 200 Flight Configuration

Table C-1a - Primary Storage Chart, Flight Plan Processing
Table C-1b - Primary Storage Chart, Surveillance Processing
Table C-1c - Primary Storage Chart, Output Processing
Table C-2a - Input/Output Transfers, Flight Plan Processing
Table C-2b - Input/Output Transfers, Surveillance Processing
Table C-2c - Input/Output Transfers, Output Processing
Table C-3a - Timing Data, Flight Plan Processing
Table C-3b - Timing Data, Surveillance Processing
Table C-3c - Timing Data, Output Processing
Table C-4 - Number and Characteristics of External Devices--200 Flight Configuration

Appendix D: Data Processing Tables for the 100 Flight Configuration

Table D-1a - Primary Storage Chart, Input and Surveillance Processing
Table D-1b - Primary Storage Chart, Output Processing
Table D-2a - Input/Output Transfers, Input and Surveillance
Table D-2b - Input/Output Transfers, Output Processing
Table D-3a - Timing Data, Input and Surveillance Processing
Table D-3b - Timing Data, Output Processing
Table D-4 - Number and Characteristics of External Devices--100 Flight Configuration

Appendix E: Description of Data Processing Functions

Appendix F: Technical Proposal Format and Content

6.2 Definitions

Active Element - See 3.6.2.4

Computer-Oriented Peripheral Device - A peripheral device of a type that is commonly used with computers and which would normally be procured from a computer manufacturer, e.g., card punch, card reader, magnetic tape unit.

Element - Any portion of the CCC system which, under program control, may be deactivated and replaced by an identical redundant portion.

Fail Safely - Operation unaffected by an element failure by virtue of activation of a redundant element. See 3.6.1

Fail Softly - A reduction in the rate at which ATC functions are performed and/or the dropping of less vital functions as necessitated by the failure of an element for which no redundant element is available. See 3.6.1

Mean Down Time (MDT) - See 3.6.2.7

Mean Up Time (MUT) - See 3.6.2.7

Mode Change - See 3.6.2.3

Mode Failure - See 3.6.2.2

Mode of Operation - See 3.6.2.1

Non-Clearing Error - An error that persists when the operation is repeated a second time.

Off-the-Shelf - See 3.2.1.1

Redundant Element - See 3.6.2.5 and 3.8.2.1.2

- Self-Clearing Error - An error that disappears when the operation is repeated a second time.
- System-Oriented Peripheral Device - A peripheral device, provided by the Government, having special requirements not satisfied by computer-oriented peripheral devices, e.g., RVDP, plan-position and tabular displays.
- Transient Failure: - See 3.6.2.6

6.3 Alphabetical Index

<u>Title</u>	<u>Paragraph</u>	<u>Page</u>
Acceptance Tests	4.2	36
Alternative to Buffering on Drums	3.4.1.1	15
Applicable Documents	2.	3
Bounds of the CCC	3.1.2	4
Cables	3.12	35
Card Punch	3.2.1.9.3	9
Card Reader	3.2.1.9.2	9
Computer-Oriented Peripheral Devices	3.2.1.9	8
Conditional Operations	3.3.2.4	13
Configuration for 325 Flights	3.5.1	17
Configuration for 200 Flights	3.5.2	17
Configuration for 100 Flights	3.5.3	17
Control and Maintenance Elements	3.2.1.10	9
Data Flow	3.3.2.3	13
Data Processing Functions, Organization, and Loads	3.3	11
Deliverable Items	1.2	1
Detailed Reliability Requirements	3.6.3	20

<u>Title</u>	<u>Paragraph</u>	<u>Page</u>
Design and Construction	3.10	30
Design Data	3.11.5	31
Documentation	3.11	30
Diurnal Load Variations	3.6.1.1	18
Error-Detection Logic	3.2.1.10.2	11
Expandability	3.2.1.6	8
Factory Acceptance Tests	4.2.2	36
Hardware Requirements	3.2.	5
Inputting and Outputting	3.3.2.2	13
I/O Channel Capabilities	3.2.1.7	8
Instruction Books	3.11.10	34
Installation	3.9	30
Magnetic Tapes	3.2.1.9.1	8
Maintenance Definitions	3.8.2	25
Maintenance Log	3.8.4.1	30
Maintenance Programs	3.7.3	24
Maintenance Programs	3.8.3.3	28
Maintenance Requirements	3.8.3	26
Maintenance Services	3.8.4	29
Mean Down Time--Mean Up Time	3.6.2.7	20
Mean Time Between Failure	3.6.3.5	22
Modular Hardware Design	3.2.1.2	5
Off-Line Maintenance Programs	3.8.3.3.2	29
Off-Line Test Equipment	3.8.3.4	29
Off-the-Shelf Elements	3.2.1.1	5

<u>Title</u>	<u>Paragraph</u>	<u>Page</u>
On-Line Maintenance	3.8.3.1.1	27
On-Line Maintenance Programs	3.8.3.3.1	28
Operation at Reduced Demand	3.3.2.6	14
Parity Check Feature	3.2.1.5	7
Peripheral Data Buffer Approach	3.4	15
Peripheral-Device Adapters	3.4.1	15
Power Supply Units	3.2.2	11
Preparation for Delivery	5.	41
Preventive Maintenance	3.8.3.1.3	27
Printer	3.2.1.9.4	9
Programmer's Reference Manual	3.7.2	23
Quality Assurance Provisions	4.	35
Radio-Frequency Interference	3.2.3	11
Reconfiguration Check	4.2.2.4.2	37
Reconfiguration Time After Failures	3.6.3.2	21
Redundancy of CCC Elements	3.2.1.4	7
Reliability	3.6	18
Reliability Definitions	3.6.2	19
Reliability for Mode A1	3.6.3.3	21
Reliability for Mode C1	3.6.3.4	21
Sequence of Functions	3.3.2.5	14
Service Conditions	3.14	35
Shared Memory	3.2.1.8	8
Software Support	3.7	22
Storage, Input/Output, and Computing Time Requirements	3.3.3	14

<u>Title</u>	<u>Paragraph</u>	<u>Page</u>
Storage Tradeoffs	3.3.2.1	13
System Configuration Requirements	3.5	17
System Maintenance Requirements	3.8	24
System Organization Requirements	3.3.2	13
Table Storage	3.3.3.1	15
Test Reports	3.11.9	33
Test Specification	3.11.8	33
Transient Failure	3.6.2.6	19
Use of Two Types of Data-Processing Machines	3.2.1.3	6
Utility System	3.7.1	22

0

Attachments:

Figures 3-1 and 3-2
Appendices A through F

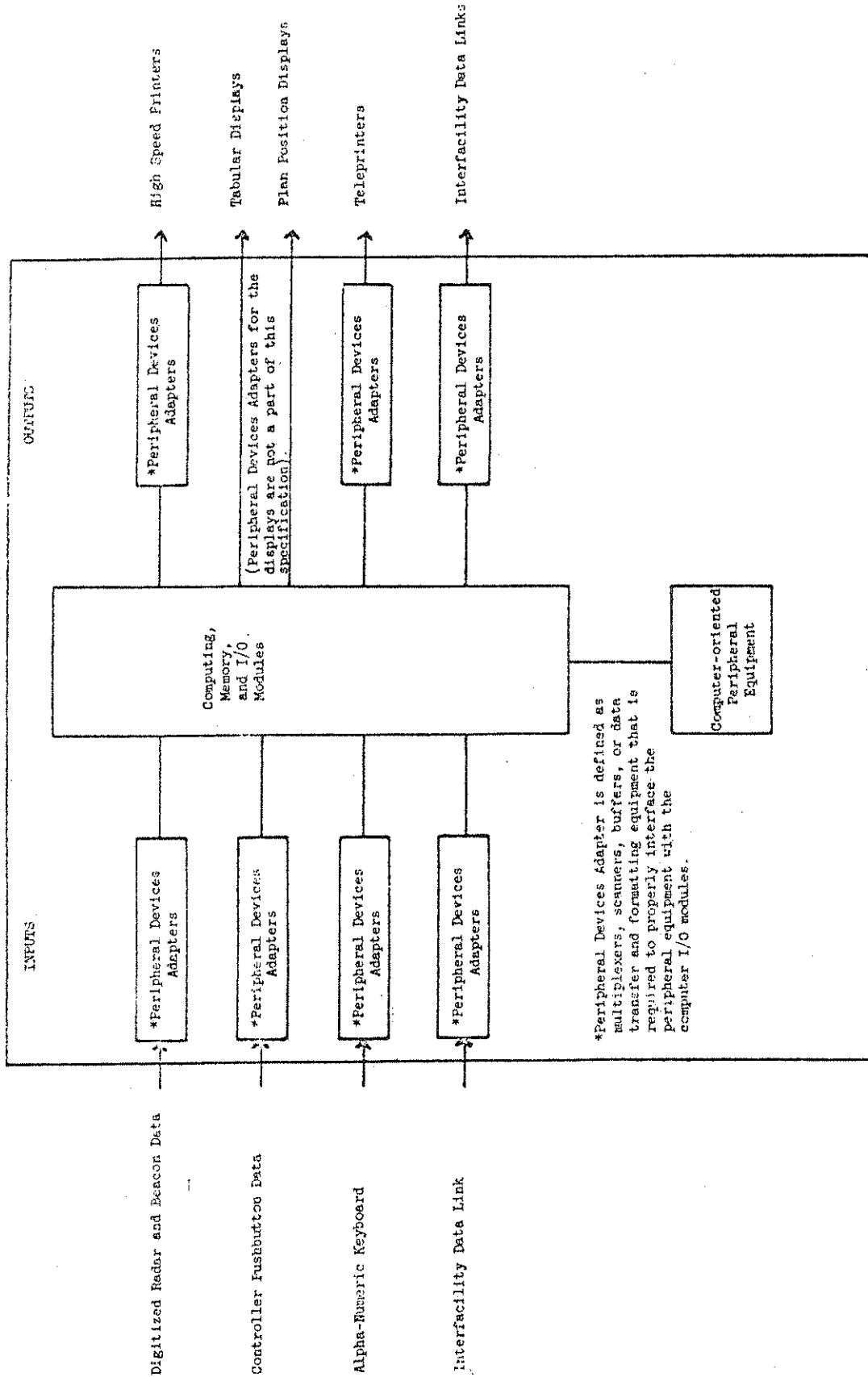

Equipment within this block is a part of the Central Computer Complex and is required as a part of this specification. The exact configuration and quantity of equipment will vary depending upon the three functional and loading configurations specified in paragraphs 3.5.1, 3.5.5, and 3.5.3.

Figure 3-1: Diagram of the CENTRAL COMPUTER COMPLEX.

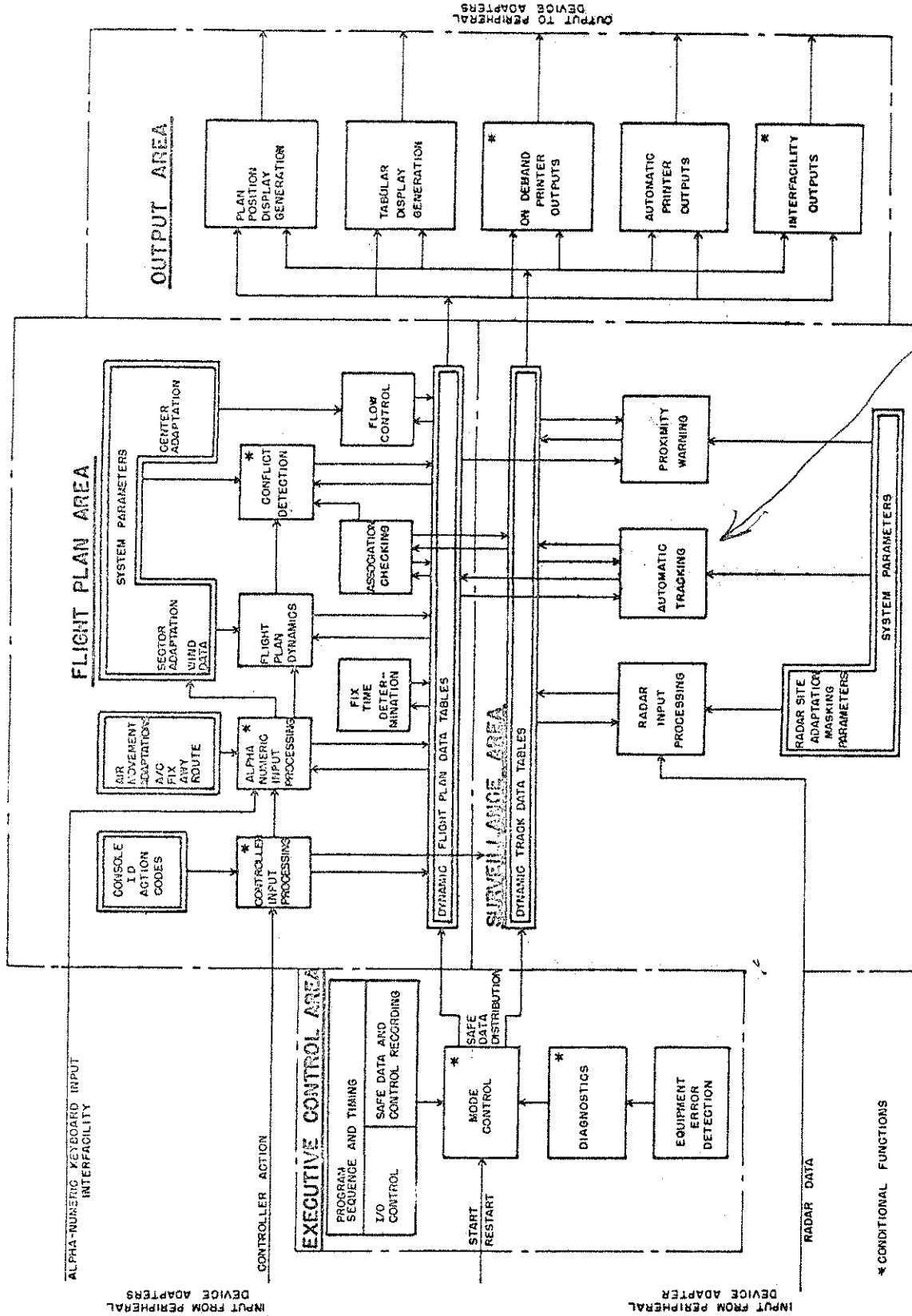

FUNCTIONAL DATA FLOW CHART FOR A TYPICAL SYSTEM

FIGURE 3-2

APPENDIX ADETERMINATION OF ADJUSTMENT FACTORS FOR COMPUTING TIME,
PROGRAM LENGTH, AND DATA LENGTH

1. Summary.- Each bidder is required to show that each of his proposed CCC configurations can adequately handle the data-processing loads described in this Specification and its appendices. The data-processing requirements are formulated in terms of computing time, program length, and data table length that apply to the computer of an existing experimental system, which cannot process the amount of data required for the specified peak traffic demand within the specified response time. Using the process outlined in this appendix, define the adjustment factors that will be used to scale to your CCC configurations from the program length, computing time, and data word length required in the computer of the experimental system. Each proposed CCC configuration must satisfy the adjusted data-processing requirements within the specified cycle time of 2.5 seconds.

2. Sample Problems.- Published data for the effective computing speed of commercially available computers are ambiguous since computing speed as such (i.e., execution time of specified instructions) is not of primary importance. The ability of the central processor to speedily execute specific processing tasks is important. A data-processing problem set has been defined, encompassing the arithmetic processes important to the data-processing tasks of the air traffic control system. For convenience the total problem set is stated as eight short problems, plus other analyses of capabilities as defined in sections 8.1 and 8.2 of this appendix. The eight problems have been coded on the computer of the experimental system. The results--program length and running time--are stated in 3. of this appendix. Each bidder must provide the following information in his proposal in order to evaluate the capability of his proposed CCC configurations to meet the stated workload requirements.

2.1 Non-Parallel Processing.- Code each problem for processing by a single computing element and supply the coded solution. This information will be used to reference the computing capability of your computing elements and must be supplied regardless of what method of processing you propose for your CCC configurations.

- (a) Your coding should be consistent with the size of your primary memory element, i.e., if your primary memory consists of several elements and the element size is small, it is invalid to process all sample problems entirely within one element. Distribute the environment for the problem--where applicable--in several elements.

Today's problem

- (b) Calculate or measure the running time for each problem.
- (c) State the running time and program length for each problem, and explain how these were derived.
- (d) Use the results obtained from the problems to define the Program Length (PLAF), Computing Time (CTAF), and Data Word Length (DLAF) Adjustment Factors that apply for single computing element processing as specified under Section 5. of this appendix.

2.2 Parallel Processing.- For each configuration for which the bidder proposes parallel processing, the bidder shall determine appropriate adjustment factors. These adjustment factors must be determined without using any redundant (see 3.6.2.5 of specification) elements, i.e., the redundant elements are assumed to be non-existent for the purpose of determining the computing capacity of a proposed configuration.

- (a) Depending on the proposed executive structure, the bidder shall determine adjustment factors for the proposed configurations whereby more than one computing element executes only one function simultaneously.
- (b) Alternately, the bidder shall determine adjustment factors that apply to any one computing element when each computing element processes a different function simultaneously.

The bidder is asked to show in detail how he determined these adjustment factors. The bidder must account in both methods for the delay introduced when more than one processor attempts to access any shared memory.

3. Results of Experimental System.- The following table states the results of the problems for the computer of the experimental system. The program length includes all necessary constants and masks. On the experimental machine, 1 instruction = 1 computer word.

Problem	Running Time (usec) E_1	Program Length (Instructions) X_1
1	4,584	10
2	918	19
3	6,868	32
4	42,612	19
5	610,768	139
6	205,512	41
7	76,512	53
8	4,736	61

4. Processing Capability of the Experimental System.- The data processor of the experimental system is characterized as a single-address, fixed binary point, single I/O channel, general-purpose, digital processor.

- (a) The processor contains a random-access ferrite-core memory of approximately 69,000 words. Each word contains 32 information bits. The basic core cycle time is 6 usec.
- (b) The processor of the experimental system contains four index registers. In addition, the right accumulator register can be used for address modification.
- (c) The standard instruction execution time is 12 usec with the following exceptions:
 - (1) Store Class instructions are 18 usec.
 - (2) Load Class instructions average 8 usec.
 - (3) Branch Class instructions average 6 usec.

- (4) Multiple instruction takes 16.5 usec, and
- (5) Divide takes 51 usec.
- (d) The instruction repertoire consists of 58 single-address fixed-point instructions.
- (e) All arithmetic registers are split into two registers each with 15-bits plus sign bit. Arithmetic commands operate on either half of or the full (not coupled) accumulator.
- (f) The processor operates in conjunction with a drum system containing a total of 75 drum fields. Each field is capable of storing 2,048 words. The average access time for a drum is 10 milliseconds and word transfer time is 10 usec.

5. Adjustment Factors.- For 5.1 (CTAF) and 5.2 (PLAF), determine separate adjustment factors using non-parallel processing, and parallel processing if proposed.

5.1 Computing Time Adjustment Factor (CTAF)

$$CTAF = \left[\frac{8}{\sum_{i=1}^8 \frac{T_i}{E_i}} \right]^{1/8}$$

where: T_i = running time for problem i on proposed CCC.

E_i = running time for problem i on computer of experimental system.

5.2 Program Length Adjustment Factor (PLAF)

$$PLAF = \left[\frac{8}{\sum_{i=1}^8 \frac{L_i}{X_i}} \right]^{1/8}$$

where: L_i = program length for problem i on the proposed CCC.

X_i = program length for problem i on the computer of experimental system.

5.3 Data Word Length Adjustment Factor (DLAF)

$$DLAF = \frac{32}{\text{word length of the proposed CCC}}$$

6. Comment.- Your are allowed reasonable freedom in the manner in which you choose to code the sample problems. Thus your coding may be efficient in running time at the expense of program storage space or vice veras. The capabilities of a particular CCC complex will dictate the desired emphasis.

6.1 If you judge that the stated environment of any problem results in an unreasonable inefficiency for your CCC, you will be allowed to restate the environment before coding and timing the problem. Should the restated environment assume a less densely packed table structure, you must adjust for this fact when determining the DLAF. In any case, the problem as originally stated must be coded, timed, and the results supplied to support your judgment.

7. Problem Statements.- The eight problems are described below. Each was chosen to represent a particular type of data manipulation representative of the data processing tasks of the air traffic control system.

- 1 Conditionality Testing and Counting
- 2 Character Testing and Moving of Data
- 3 Bookkeeping - Transfer Tables
- 4 Floating Point Arithmetic
- 5 Single Bit Testing
- 6 Fixed Point Arithmetic with Byte Manipulation - Dual Arithmetic
- 7 Two Bit Testing and Depositing of Data
- 8 Indexing and Chaining of Data

8. Data Transfer Capability and Effect on Computing Speed.- The results of this section do not affect any adjustment factors. This data is desired to aid only in the evaluation. It is intended to yield a quick means of grossly comparing the data transfer capabilities of a number of proposed equipment configurations. The bidder is asked to supply actual timing data or computed times for the stated problems.

8.1 Input/Output Transfers.- Described below are five input/output transfers. Those transfers applicable to your proposed configurations are to be used in determining the data asked for in sections 8.1.1 and 8.1.2.

- (a) Transfer a 620_8 * word block of data starting from 100_8 on drum field XX to core memory. The data is to be placed in core memory locations 20_8 thru 637_8 . At the time the I/O command is given assume that the drum read heads are just passing over location 101_8 .
- (b) Transfer a 620_8 word block of data starting from location 640_8 in core memory to drums. The data is to be placed in drum locations 20_8 thru 637_8 on drum field YY. At the time the I/O command is given assume that the drum write heads are just passing over location 21_8 .
- (c) Write a 620_8 word record on tape drive #1. The data is in core memory locations 1460_8 thru 2277_8 . Assume that the tape is at the load point.
- (d) Transfer a 620_8 word block of data from any other bulk storage medium, other than drums or tapes, proposed in your system into core memory locations 2300_8 thru 3117_8 . For purposes of calculating transfer time assume average access time to this storage device.
- (e) Transfer a 620_8 word block of data contained in core memory locations 3120_8 thru 3737_8 to any other bulk storage medium, other than drums or tapes, proposed in your system. For purposes of calculating transfer time assume average access time to this storage device.

8.1.1 Individual Transfer Times.- For each of the five transfers described above, which apply to your configuration, you shall calculate the total time required to perform the transfer. The total shall include the time required from the moment the I/O command is given to the completion of the transfer.

8.1.2 Simultaneous Transfer Times.- Calculate the minimum time necessary to simultaneously complete transfers a, c, and e for each of the three proposed system configurations. If any proposed configuration is not capable of simultaneous I/O transfers, sum up the times calculated for the individual transfers.

8.2 Effect on Computing Speed Due to Simultaneous Transfer of Data.- Problem 2 - Character Testing and Moving of Data, of section 7. is placed in memory location 100_8 and beyond. Location A and B of that problem shall be 200_8 and 240_8 , respectively. A block of data 1500_{10} words long is to be transferred from your secondary storage medium into core memory.

8.2.1 State the amount of time required to execute problem 2 when the 1500_{10} word block transfer is started before commencing with problem 2 and continues while problem 2 is executed. The data is to be placed in memory location 300_8 , and beyond.

* Subscripts indicate number system used.

8.2.2 State the amount of time required to execute the problem of 8.2.1 when the data is to be placed in memory location 40400₈ and beyond. (It is anticipated that problem 2 will be finished before the transfer is completed.)

Problem 1 - Conditionality Testing and Counting

Consider a multi-block parallel table with 100 entries. In one block there is a one-bit item called INDI. In the low order 6-8 bits (choose a number convenient to your machine) of another block is a counter, CNTR. For each entry in which INDI = 1 and CNTR is not all 1's add 1 to CNTR. Time the case for processing the 100 entries when.

- a) Entries 0 through 29 have INDI = 0, CNTR = 0
- b) Entries 30 through 59 have INDI = 1, CNTR = all 1's
- c) Entries 60 through 99 have INDI = 1, CNTR ≠ all 1's

SUGGESTED FLOW DIAGRAM:

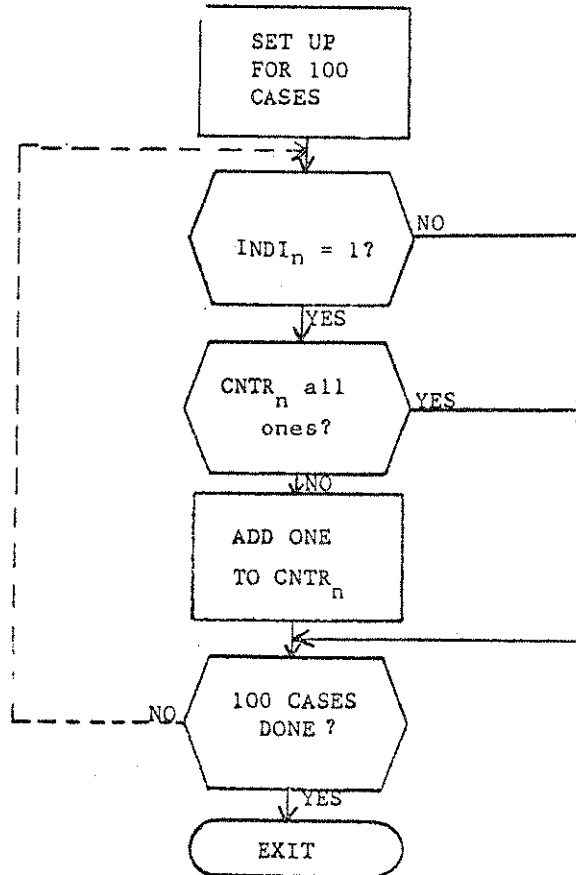

Problem 2 - Character Testing and Moving of Data

At location A, there is a string of not more than 15 characters ending with the character "/". Each character will be 6-8 bits. (Choose a number convenient to your machine.) Move the string excluding the "/" to location B, and leave the character count in an index register. Time the case where 10 characters precede the slash.

SUGGESTED FLOW DIAGRAM:

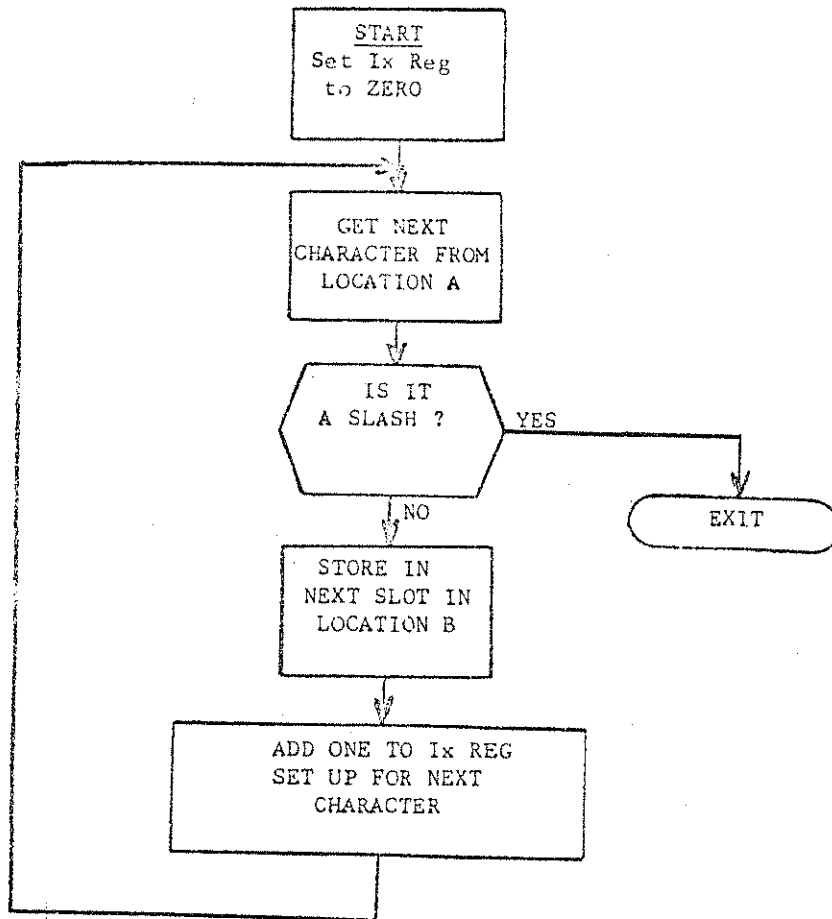

Problem 3 - Bookkeeping - Transfer Tables

Consider a two-block (block A and block B) parallel table with 10 entries each. For each entry in block A and its corresponding entry in block B find the leftmost 1 bit of the "exclusive or" combination of the two entries. Clear the corresponding bit of the entry in block A to positive zero and transfer to a subroutine corresponding to this bit position. The environment consists of:

ENTRY	BLOCK A	BLOCK B
0	111111...111	11110000...000
1	111111...111	11111000...000
2	111111...111	11111100...000
3	111111...111	11111110...000
4	111111...111	11111111...000
5	000000...000	0000000011111...111
6	000000...000	0000000001111...111
7	000000...000	0000000000111...111
8	000000...000	0000000000011...111
9	000000...000	0000000000001...111

NOTE: Analysis of the stated environment shows that only the leftmost 14 bits are significant.

SUGGESTED FLOW DIAGRAM: (Problem 3)

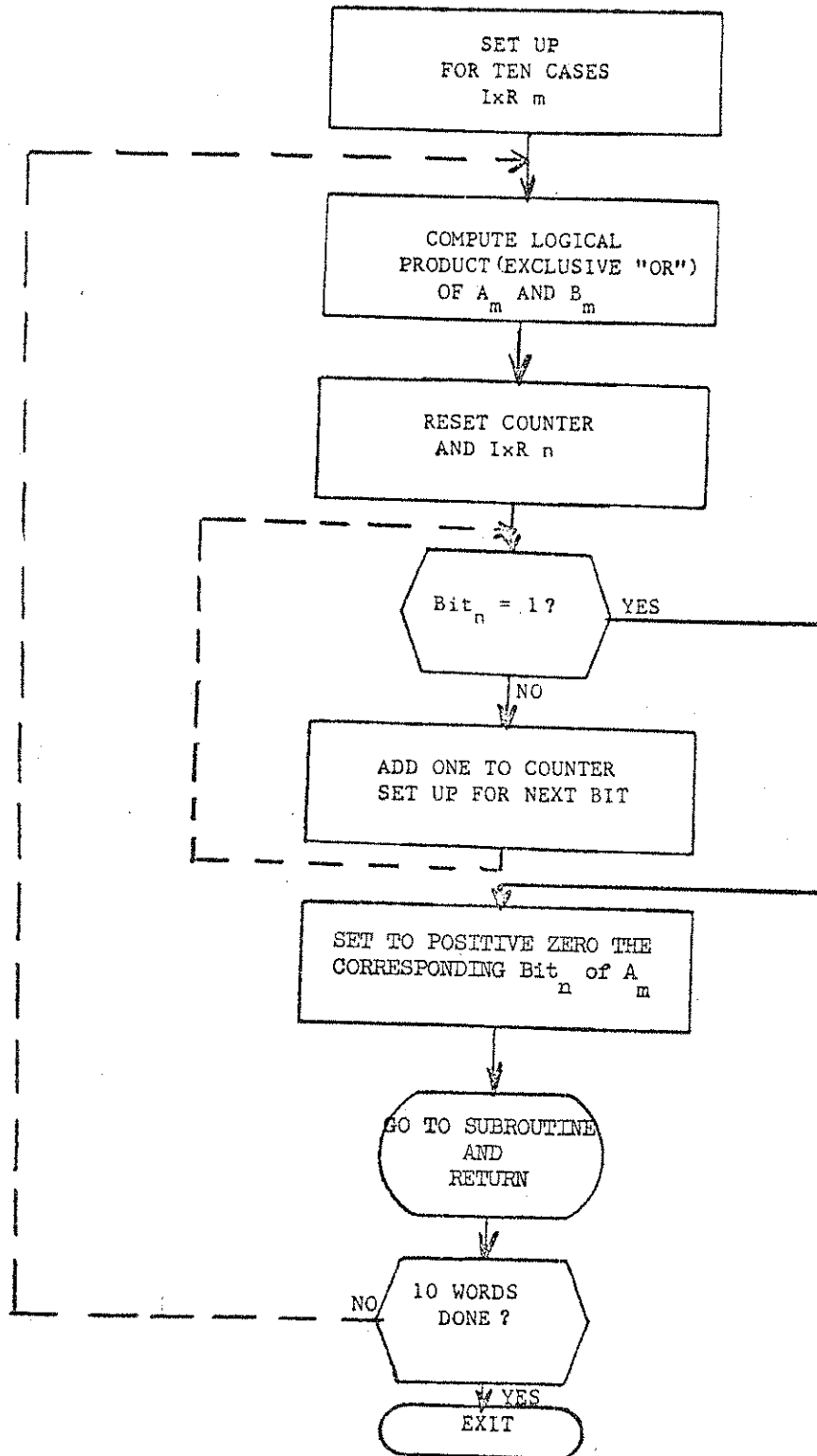

SUGGESTED ALTERNATE FLOW DIAGRAM: (Problem 3)

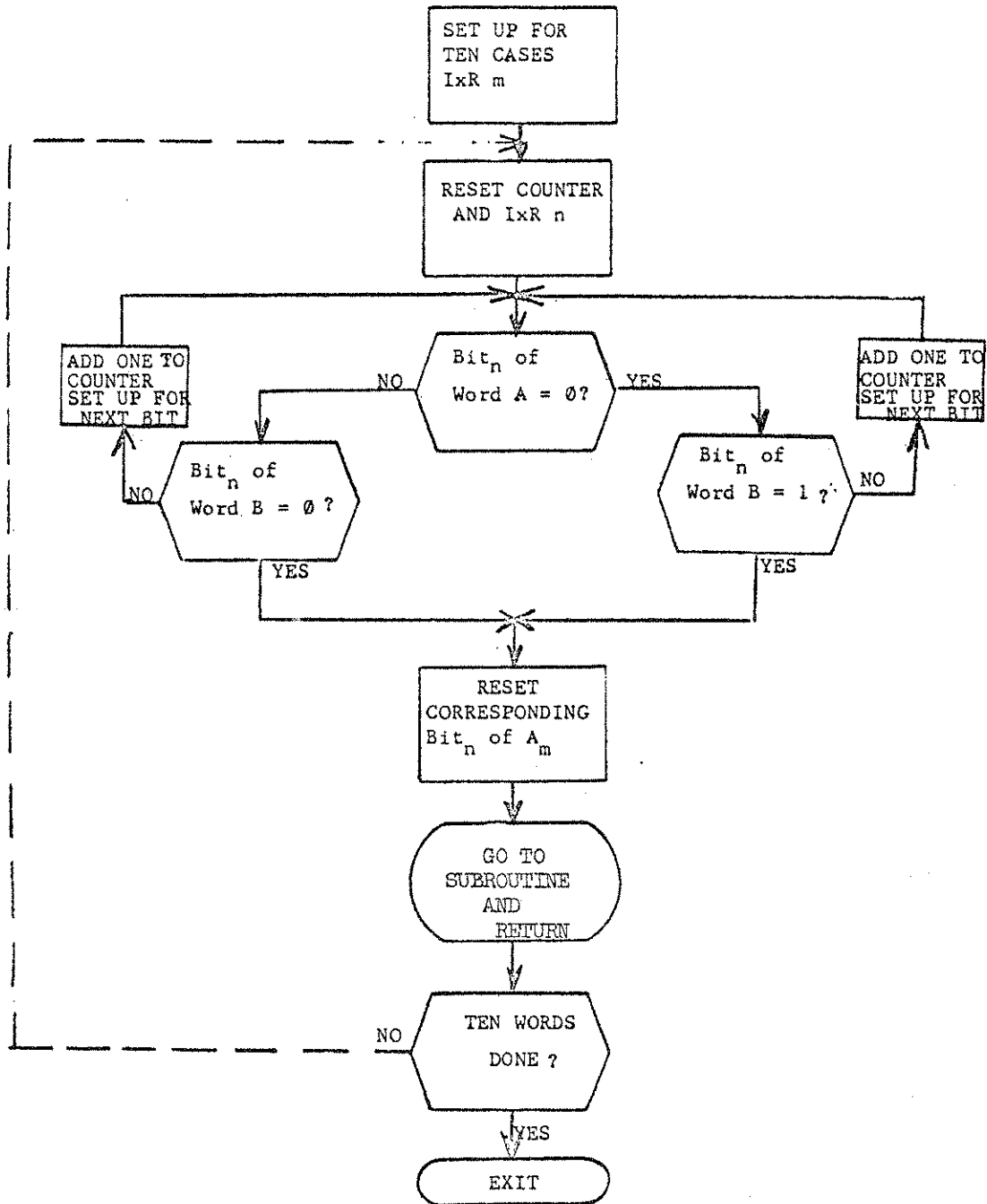

Problem 4 - Floating Point Arithmetic

Consider an 8-block table with 100 entries. For every entry A, B, C, D, E, and F are full normalized floating point numbers located in block 1 through 6 respectively. For every entry find:

$$G = (A-B)^2 + (C-D)^2$$

and store in block 7. Compute

$$H = (G/E) \times F$$

and store the result in block 8. Assume that all necessary "preshifting" is within the free range of your computer. If the time required to execute floating point instructions is a variable in your machine, choose entries A, B, C, D, E, and F such that the average instruction execution time is obtained.

why use FP ?

*continuous
→ part of
AP.*

Problem 5 - Single Bit Testine

The table environment consists of:

TABLE I -- 40 Registers

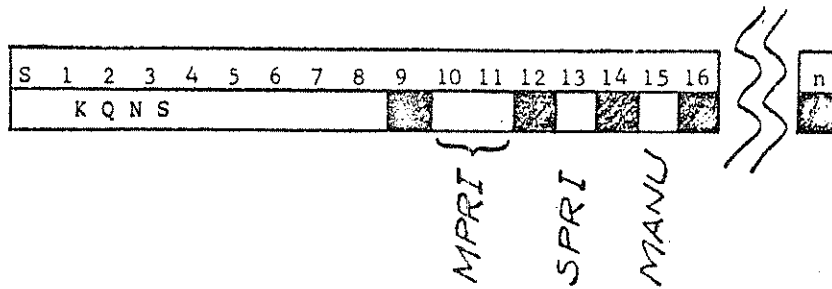

ITEM VALUES FOR TABLE I

REGISTERS	KQNS	MANU	MPRI	SPRI
0-19	200...219	0	2	0
20-24	220...224	0	1	0
25-29	225...229	1	1	0
30-39	230...239	0	1	1

n = word length of your computer. All unmarked bits contain information which must not be destroyed.

TABLE II -- 500 Registers (Problem 5)

Block 1

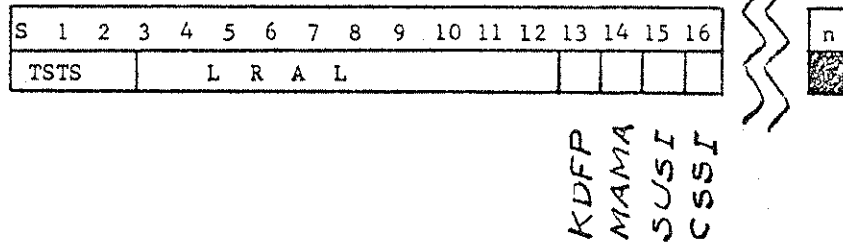

Block 2

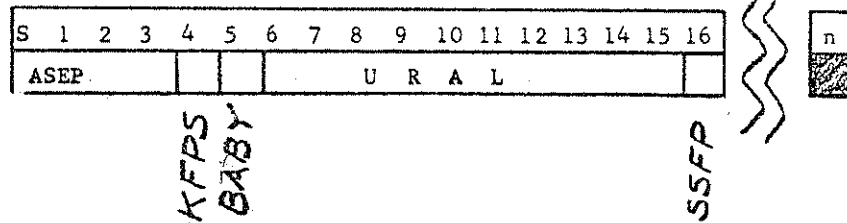

Block 3

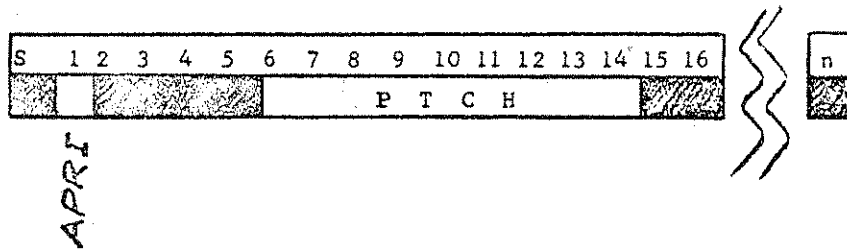

n = word length of your computer. All unmarked bits contain information which must not be destroyed.

ITEM VALUES FOR TABLE I (Problem 5)

REGISTER(S)	APRI	ASEP	BABY	CSSI	KDFP	KFPS	LRAL	MAMA	PTCH	SSEP	SUSI	TSTS	URAL
0-197	1			1		1						1	200
197-199						1				1		1	
200-219						1					1		
220						2						5	
221-224						2						7	
225						2						1	
226						2						5	
227-229						2				1			
230-232						2					1		
233-234			1	1		2						2	
235-236						2	200						
237-239						2	200	1					
240-248						1							
249-309						1						1	
310-359					1	1						1	
360-399						1						7	
400-436						1				1		1	
437-439						1						1	
440-476						1						6	
477-479						1						6	
480-489												6	
490-499	Y											1	Y

(Blank spaces equivalent to positive zero)

TABLE III -- 12 Registers TS1 - TS12 (Problem 5)

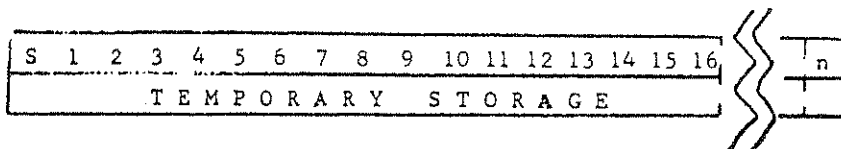

n = word length of your computer.

Problem 5 - Problem Statement

1.0	In all cases	Set to check MPRI for n cases. n = 40
1.1	If $MPRI_n \neq 1^*$	Go to 1.14
1.2	If $MPRI_n = 1$	Set: $TS1 = n$ $TS2 = KQNS_n$ ** $TS3 - TS12 = \emptyset$
1.3	If $SPRI_n = \emptyset$	Set: $TS3 = 1$
1.3.1	If $MANU_n = \emptyset$	Set: $MPRI_n = \emptyset$
1.3.2	If $MANU_n = 1$	Set: $MPRI_n = 2$ $TS4 = 1$
1.4	If $SPRI_n = 1$	Set: $MPRI_n = 2$ $TS4 = 1$
1.5	If $SSFP_{KQNS_n} = 1$ or If $SUSI_{KQNS_n} = 1$ or If $TSTS_{KQNS_n} = 7$	Set: $MPRI_n = \emptyset$ Go to 1.14
1.6	Otherwise	Set: $APRI_{KQNS_n} = \emptyset$ $TS5 = LRAL_{KQNS_n}$ $TS6 = URAL_{KQNS_n}$
1.7	If $BABY_{KQNS_n} = 1$ or If $MAMA_{KQNS_n} = 1$	Set: $TS7 = PTCH_{KQNS_n}$
1.8	If $TS5 = TS6$	Go to 1.14
1.9	Otherwise	Set: $TS8 = TS5 - ASEP_n$ $TS9 = TS6 + ASEP_n$
1.10	If $CSSI_{KQNS_n} = 1$	Go to 1.13
1.11	If $TSTS_{KQNS_n} = \emptyset$ or 6	Set: $TS10 = 1$ Go to 1.13

* Subscripts indicate values used to get relative location in tables.

** TS = Temporary Storage, all items stored in temporary storage are to be stored right justified.

1.12 Otherwise	Set TS10 = 2
1.13 In all cases	Set up to check k channels. k = 500
1.13.1 IF $KFPS_k = 1$ and If $KDFP_k = 0$ and If $SSFP_k = 0$ and If $SUSI_k = 0$ and If $TSTS_k \neq 7$	Set: TS11 = k
1.13.2 If $CSSI_k = 1$	Go to 1.13.5
1.13.3 If $TSTS_k = 0$ or 6	Set: TS12 = 1 Go to 1.13.5
1.13.4 Otherwise	Set TS12 = 2
1.13.5 If $TS11 = 0$ or $KQNS_n$ or $PTCH_n$	Go to 1.13.7
1.13.6 Otherwise	Go to Subroutine A, Return to 1.13.7
1.13.7 If 500 channels have not been checked	Then: Set for next channel Go to 1.13.1
1.14 If 40 cases have not been checked	Then: Set for next case Go to 1.1
1.15 Otherwise	EXIT

SUGGESTED FLOW DIAGRAM: (Problem 5)

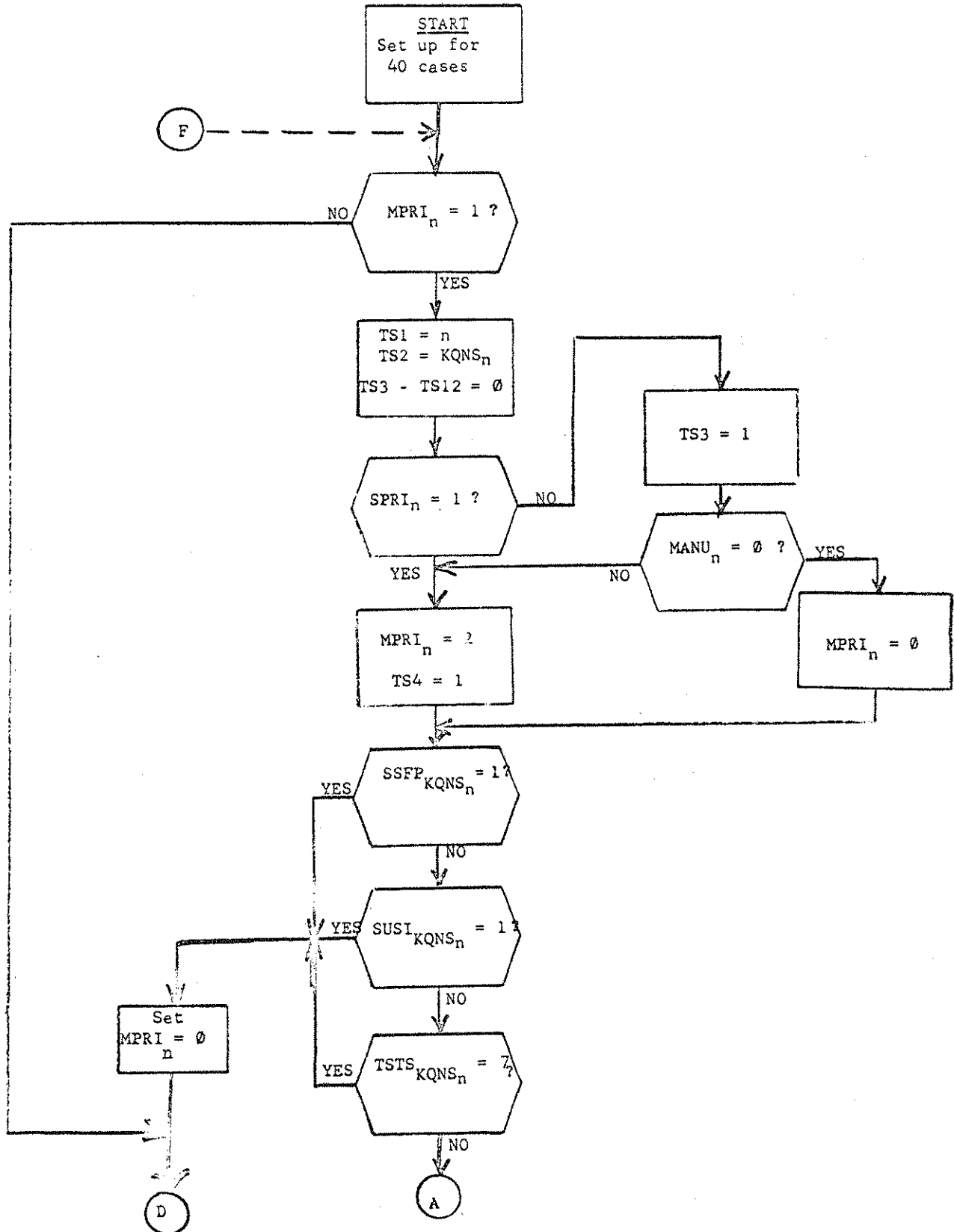

SUGGESTED FLOW DIAGRAM: (Problem 5)
(Continued)

-A21-

FAA-ER-606-063

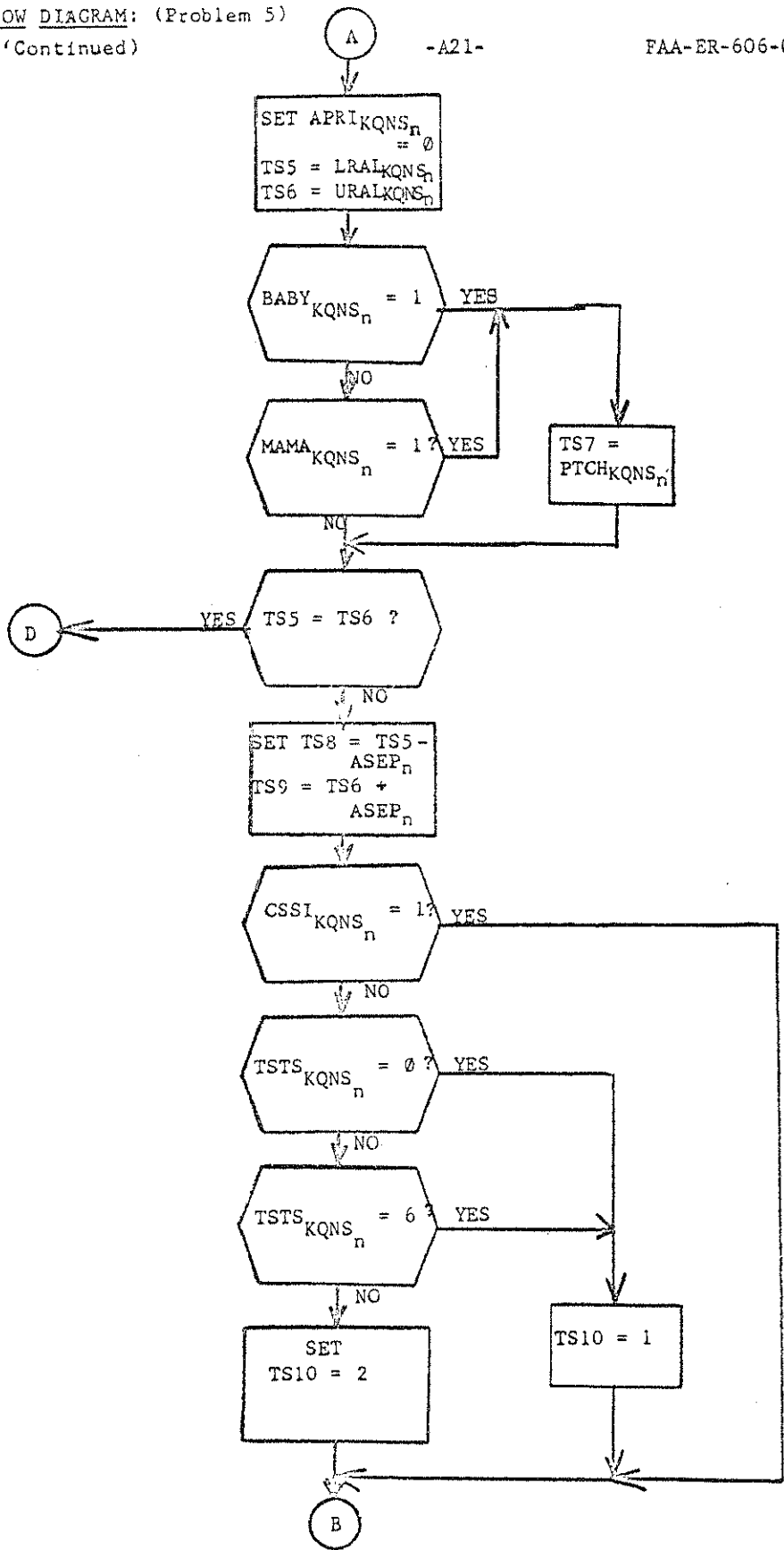

SUGGESTED FLOW DIAGRAM: (Problem 5)

(Continued)

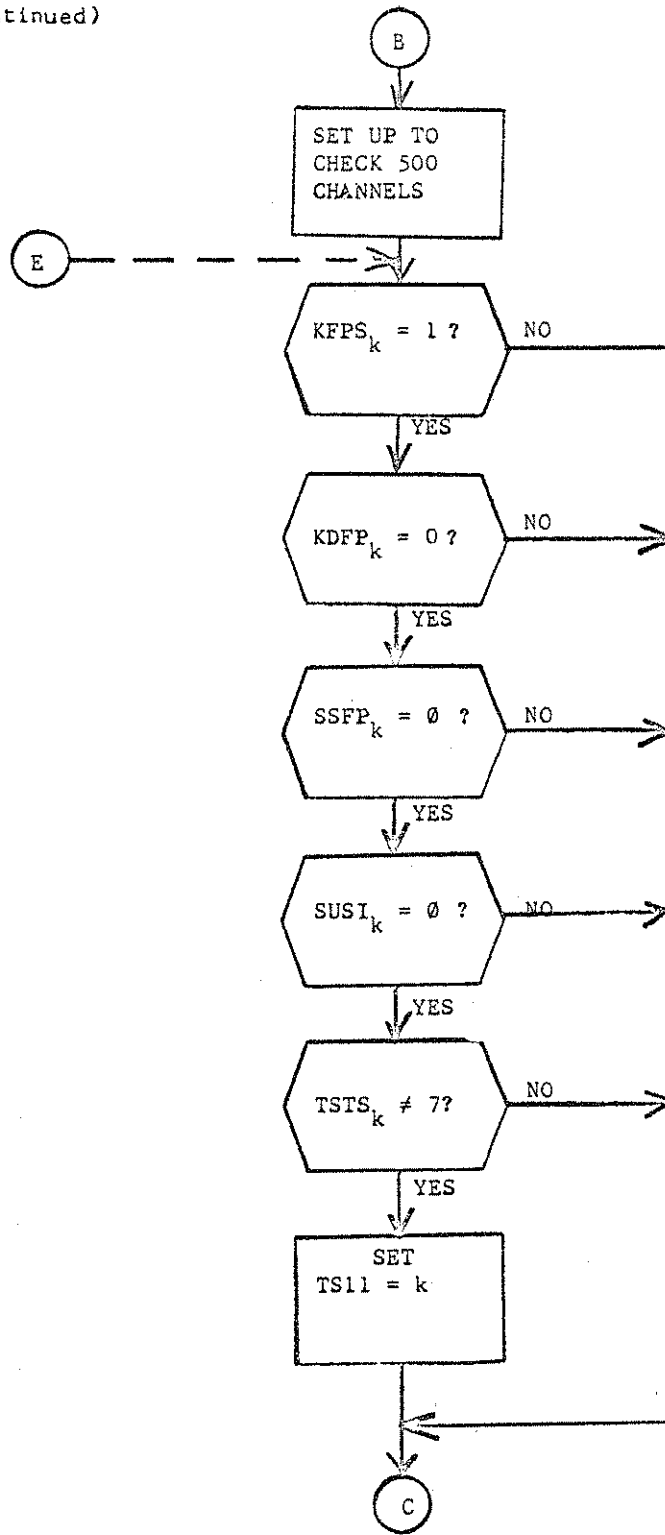

SUGGESTED FLOW DIAGRAM: (Problem 5)

(Continued)

-A23-

FAA-ER-606-063

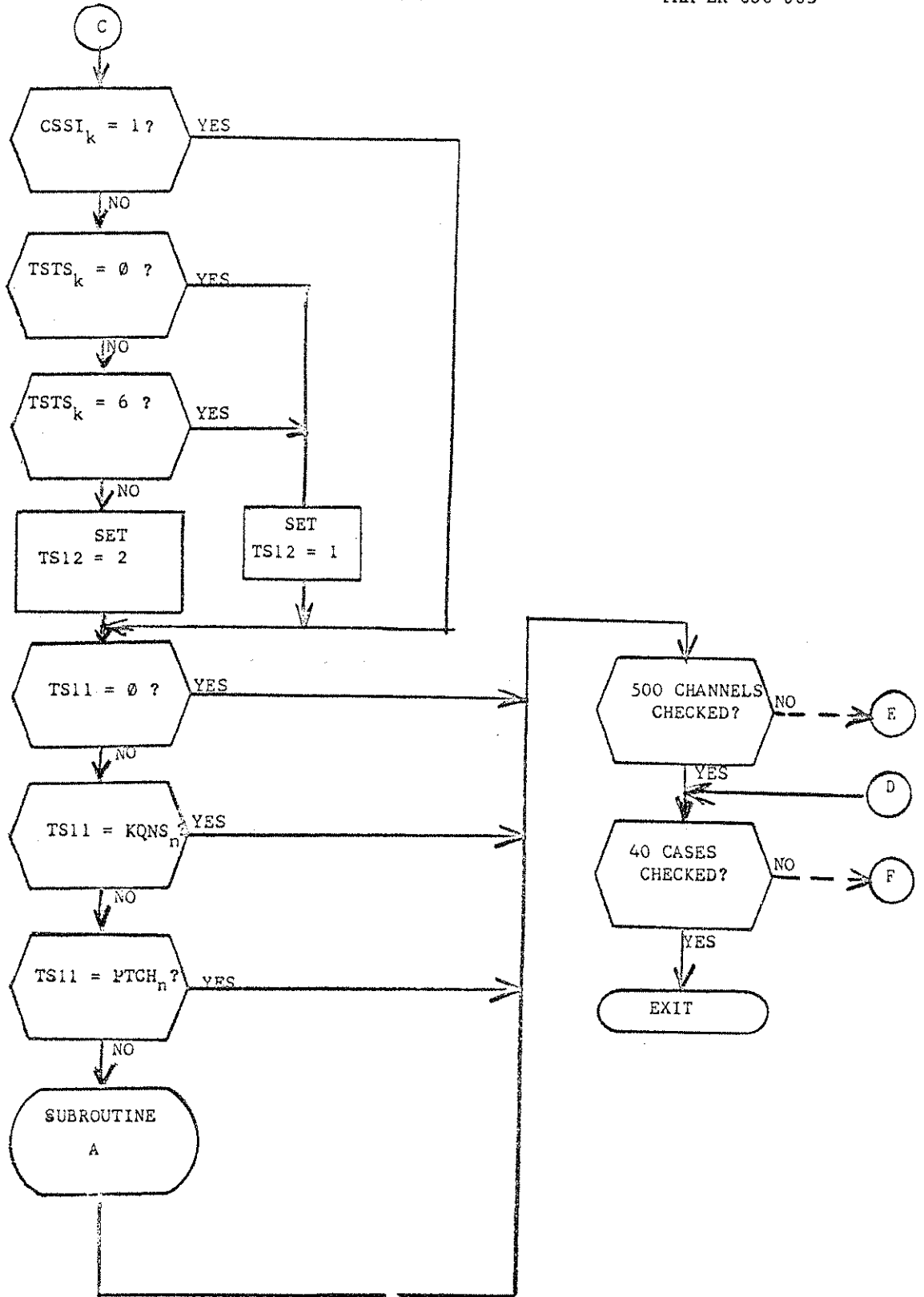

Problem 6 - Fixed Point Arithmetic

The environment consists of:

TABLE I -- 500 Registers

Block 1

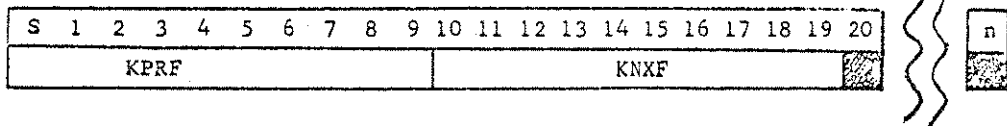

Block 2*

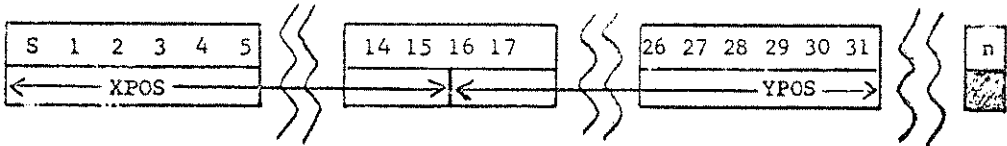
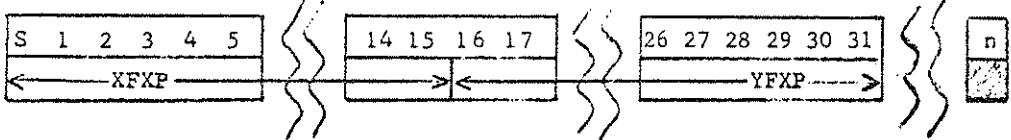

TABLE II -- 1000 Registers

Block 1*



Block 2

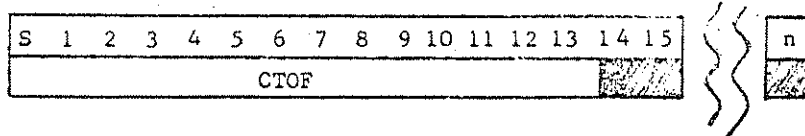
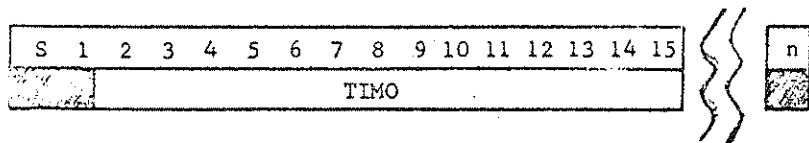

TABLE III -- 1 Register



*XPOS, YPOS, XFXP, YFXP are signed numbers. They may be repositioned in your computer word if desirable to take advantage of byte manipulation and arithmetic.

n = number of bits in your computer word. All unmarked (shaded) bits contain information that must not be destroyed.

Problem 6 - Problem Statement

1.0 For all cases

Set up to do n cases. n = 500

1.1 If all cases done

EXIT

1.2 If all cases not done

Set: $TS1 = KPRF_n^*$

$TS2 = KNXF_n$

Find:

$$X = XFXP_{TS2} - XFXP_{TS1}$$

$$Y = YFXP_{TS2} - YFXP_{TS1}$$

$$T = CTOF_{TS2} - CTOF_{TS1}$$

$$\dot{X} = (X/T)$$

$$\dot{Y} = (Y/T)$$

$$T_i = TIMO - CTOF_{TSI}$$

$$DX = T_i \dot{X}$$

$$DY = T_i \dot{Y}$$

Set: $XPOS_n = XFXP_{TS1} + DX$

$YPOS_n = YFXP_{TS1} + DY$

Set up to do next case

Go to 1.1

*TS1 etc., indicates temporary storage locations. All items stored in temporary storage are to be stored right justified.

Subscripts indicate values used to get relative locations within a table.

Problem 7 - Two Bit Testing and Depositing of Data

The environment consists of:

TABLE I -- 500 Registers

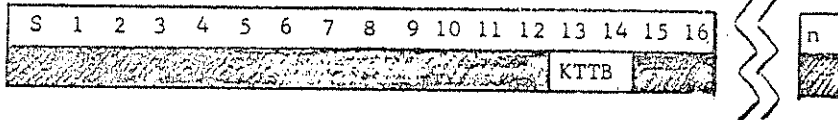

- Register 0-124 KTTB = 0
- Register 125-249 KTTB = 1
- Register 250-374 KTTB = 2
- Register 375-499 KTTB = 3

TABLE II -- 500 Registers

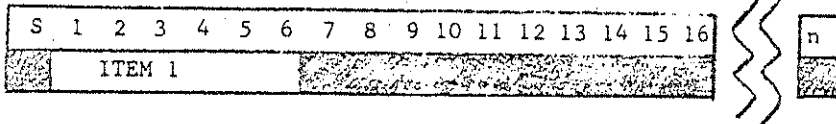

TABLE III -- 500 Registers

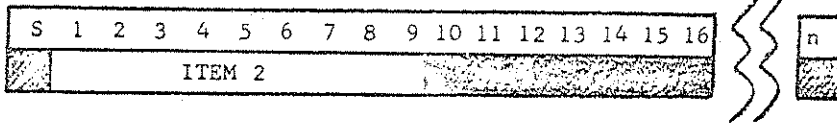
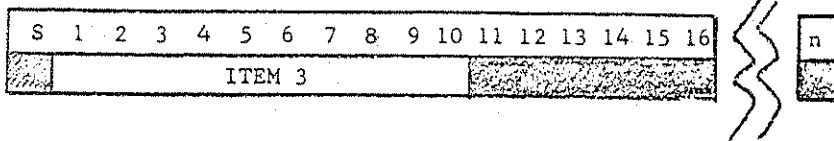

TABLE IV -- 500 Registers



n = word length of your computer. All unmarked (i.e., shaded) bits contain information which must not be destroyed.

Problem 7 - Problem Statement

1.0	In all cases	Set up to test n cases. n = 500
1.1	If through 500 cases	EXIT
1.2	If not through 500 cases	
1.2.1	If $KTB_n = 0^*$	Set: ITEM $1_n = 10$ ITEM $2_n = 100$ ITEM $3_n = 300$ Go to 1.1
1.2.2	If $KTB_n = 1$	Set: ITEM $1_n = 20$ ITEM $2_n = 200$ ITEM $3_n = 400$ Go to 1.1
1.2.3	If $KTB_n = 2$	Set: ITEM $1_n = 30$ ITEM $2_n = 300$ ITEM $3_n = 500$ Go to 1.1
1.2.4	If $KTB_n = 3$	Set: ITEM $1_n = 40$ ITEM $2_n = 400$ ITEM $3_n = 600$ Go to 1.1

* n = Relative location of data within its table.

SUGGESTED FLOW DIAGRAM: (Problem 7)

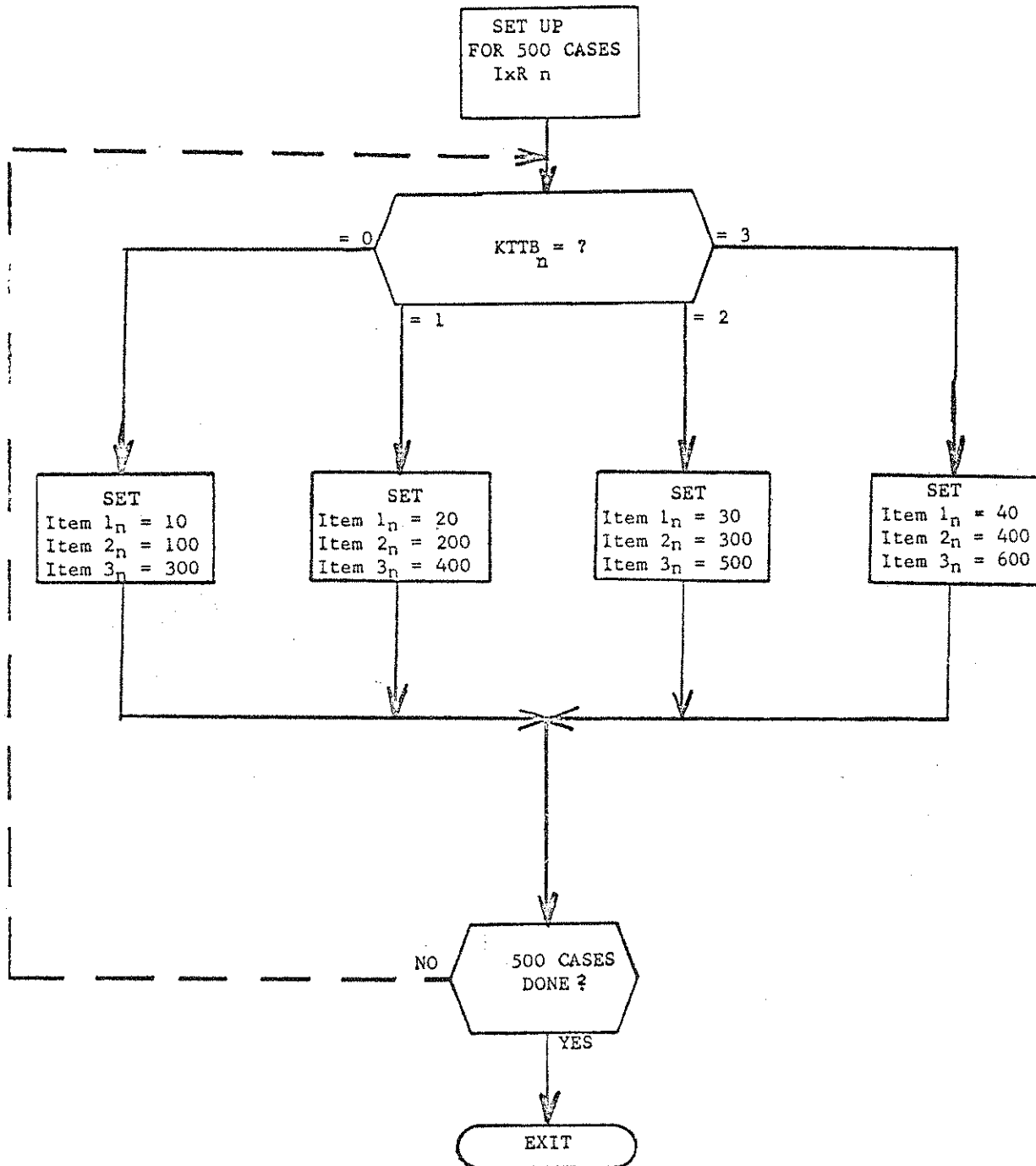

Problem 8 - Indexing and Chaining of Data

The environment consists of:

TABLE I -- 10 Registers

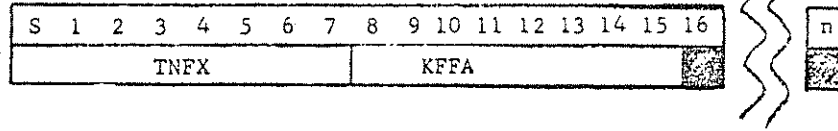

TABLE II -- 10 Registers

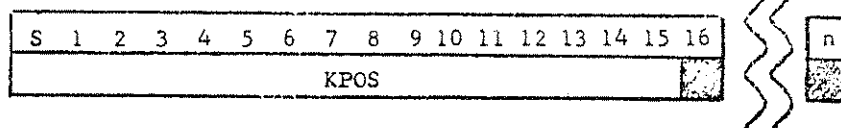

TABLE III -- 10 Registers

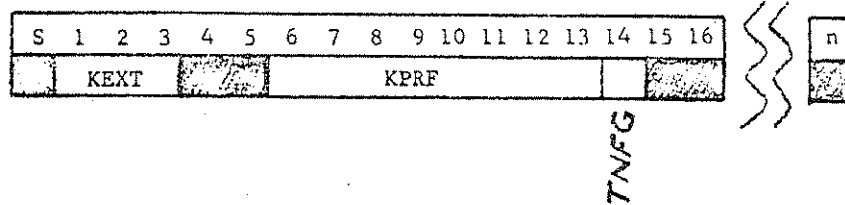

TABLE IV -- 250 Registers

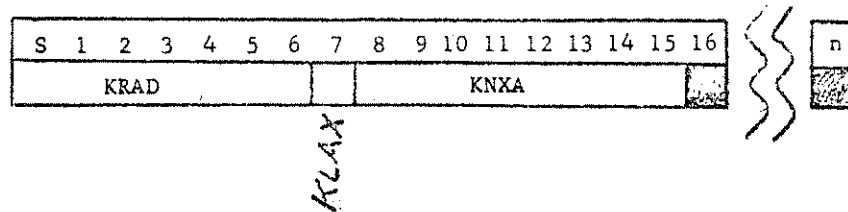
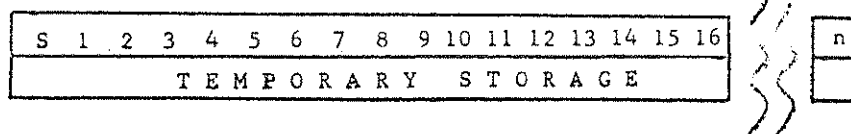

TABLE V -- Temporary Storage -- TS1-TS4



n = word length of your computer. All unmarked bits contain information which must not be destroyed.

ITEM VALUES FOR TABLES I, II, III (Problem 8)

REGISTERS	KEXT	KFFA	KFOS	KFRF	TNFG	TNFX
0	2	31	*	36		* arbitrary constant
1	4	180		249		
2	1	126		126		
3	7	111		113		
4	3	100		188		
5	4	223		190		
6	5	172		172		
7	7	211		231		
8	1	162		162		
9	2	230	↘	199		

ITEM VALUES FOR TABLE IV (Problem 8)

REGISTER	KLAX	KNXA	KRAD
31	0	36	50
36	0	152	
37	1	0	
100	0	114	
111	0	112	
112	0	113	
113	1	0	
114	0	188	
126	0	127	
127	0	37	
151	0	153	
152	1	0	
153	1	0	
154	1	0	
161	0	249	
162	0	182	
172	0	173	
173	1	0	
180	0	161	
182	1	0	
188	0	198	
190	0	151	
196	0	231	
198	1	0	
199	0	210	
200	1	0	
209	1	0	
210	0	209	
211	0	196	
223	0	224	
224	0	190	
230	0	199	
231	0	154	
249	0	200	

Problem 8 - Problem Statement

<p>1.0 In all cases</p> <p>1.1 In all cases</p> <p>1.2 If $KLAX_{TS2} = 1$</p> <p> 1.2.1 If n cases done</p> <p> 1.2.2 Otherwise</p> <p>1.3 If $KLAX_{TS2} = 0$</p> <p> 1.3.1 If $KEXT_n = 2$</p> <p> 1.3.2 If $KEXT_n = 4$</p> <p> 1.3.3 If $KEXT_n = 7$</p> <p> 1.3.4 Otherwise</p> <p>All Subroutines Return to 1.4</p> <p>1.4 In all cases</p> <p> 1.4.1 If ACC = negative</p> <p> 1.4.2 If ACC = positive</p> <p>1.5 In all cases</p>	<p>Set to check KFFA for n cases. n = 10</p> <p>Set: $TNFX_n^* = 0$</p> <p> ** $TS1 = KFFA_n$</p> <p> $TS2 = KNXA_{KFFA_n}$</p> <p>EXIT</p> <p>Set for next case</p> <p>Go to 1.1</p> <p>Set: $TS3 = KPRF_n$</p> <p> $TS4 = KRAD_{TS3}$</p> <p>Go to Subroutine A (Exit with ACC negative)</p> <p>Go to Subroutine B (Exit with ACC positive)</p> <p>Set: $ACC = KPOS_n$</p> <p> (right adjusted)</p> <p>Go to Subroutine C (Exit with ACC negative)</p> <p>Go to Subroutine D (Exit with ACC positive)</p> <p>Set: $TNFG_n = 0$</p> <p>Set: $TNFG_n = 1$</p> <p>Set: $TS2 = KNXA_{TS2}$</p> <p>Go to 1.2</p>
---	--

* Subscripts indicate the relative location of the item within its table.

** All items stored in temporary storage are to be stored right justified

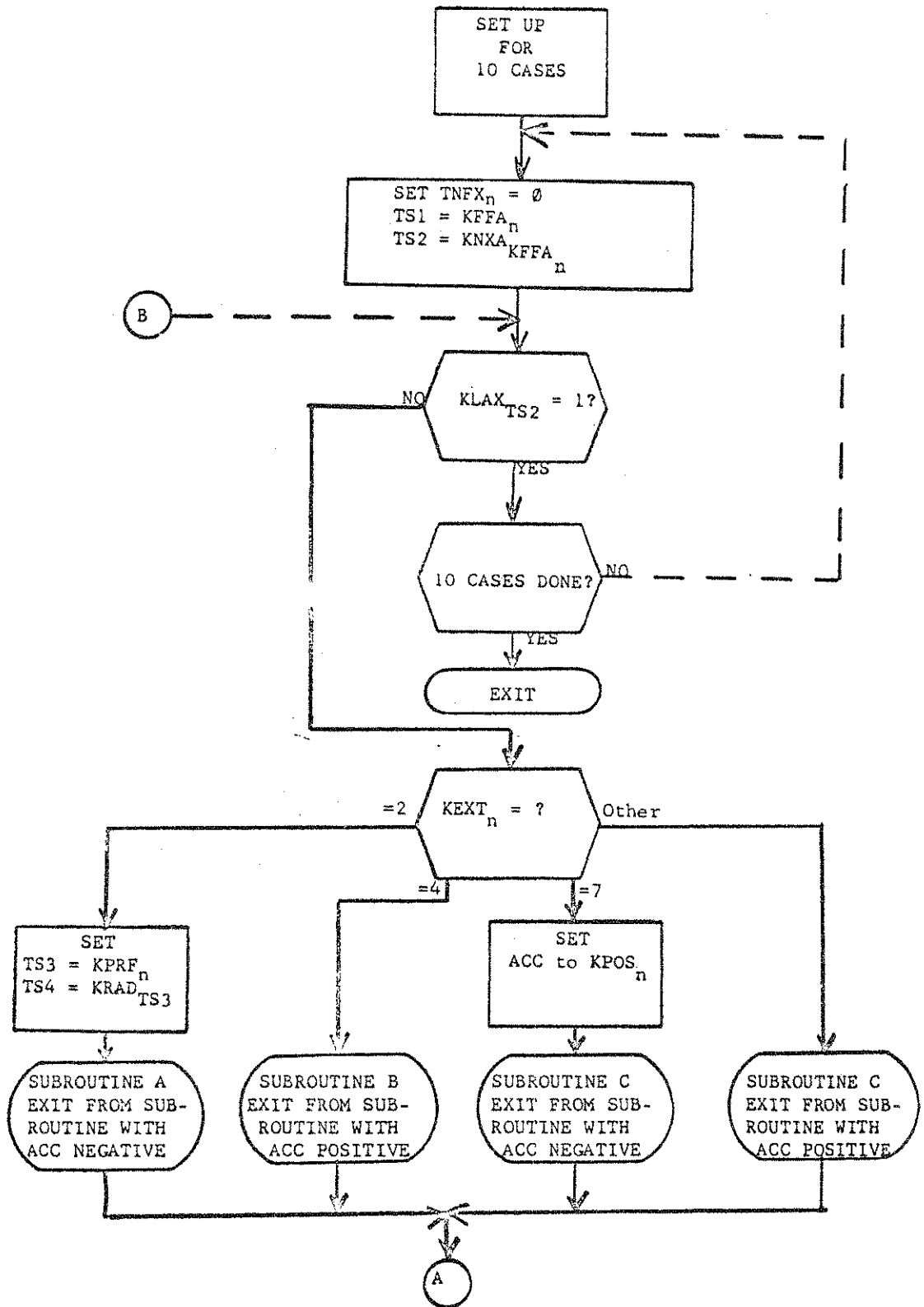

SUGGESTED FLOW DIAGRAM (Problem 8 - continued)

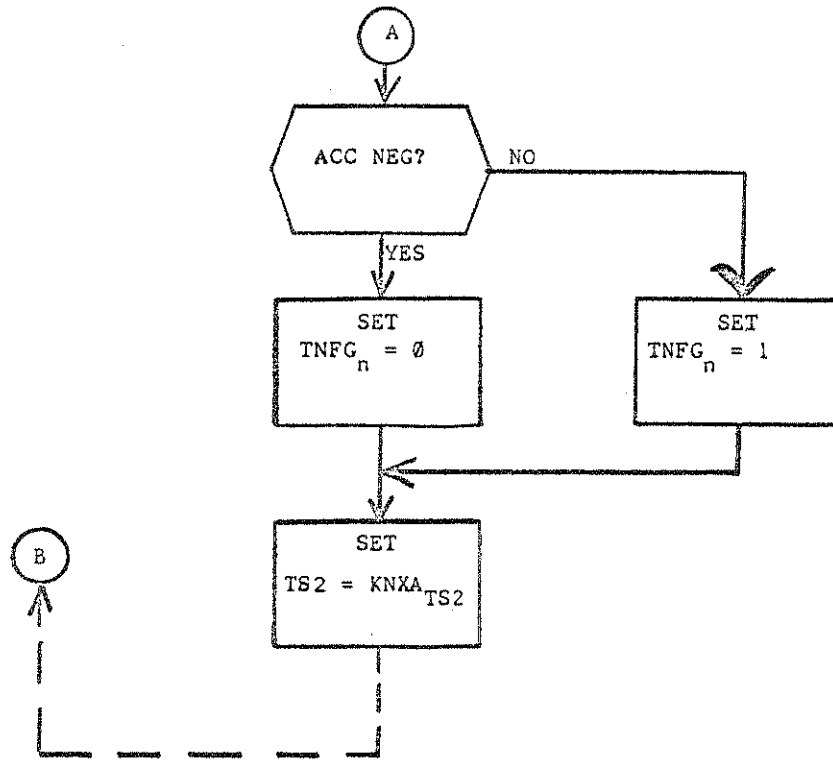

APPENDIX BDATA PROCESSING TABLES FOR THE 325 FLIGHT CONFIGURATION

1. Description of Data Contained in Tables.- The following paragraphs describe the data contained in each column of the data processing tables which are included in this appendix.

1.1 Primary Storage (Tables B-1a, b, and c).- These tables present the primary storage required during the operation of each function.

- (a) Program Length.- The length of all programs and common program routines required to perform a function is listed. The capital letter under Program Length represents a program routine common to several functions. The value for this shared program routine will be found in paragraph 1.4--Legend for Tables. The stated length of programs and program routines applied for symbolic coding. No higher order programming language was used in the experimental system. The required length of programs and program routines is to be adjusted using the adjustment factor PIAF (see Appendix A).
- (b) Data Table Storage.- The Data Table Storage column lists the sum of static and dynamic tables to which the function requires access. Each of the capital letters under Data Table Storage represents a data block common to several functions. (See Paragraph 1.4) These common data blocks are identified so that requirements for communication between primary and bulk storage can be determined consistent with the function sequence of a particular data processing organization. The small letter n represents controlled flight load and identifies those tables which may be processed in several passes. Exercising the option to execute a function in several passes will imply reduced primary storage requirements. The data tables are based on a 32-bit word, and their length may be assumed to be inversely proportional to word length.
- (c) Working Table Storage.- The stated amount of table storage is required for data manipulation internal to the stated function. This working storage is required in addition to listed Peripheral Data Storage requirements. The working tables are temporary, i.e., they lose all value when the function has been completed. The working storage tables are based on a 32-bit word, and their length may be assumed to be inversely proportional to word length.

- (d) Peripheral Data Storage.- For every listed function, the amount of Peripheral Data Storage refers to the size of the input or output table required; the table size is based on the assumption that the entire peripheral table will be transferred to or from an external buffer. If all buffering is done external to the CCC, the peripheral table space is temporary. If primary storage is used for internal buffering, the stated storage must be permanently reserved for this purpose; thus, primary memory must have space allocated for the sum of all internal buffered peripheral tables during the operation of every function (see section 3.4).
- (e) Executive Control.- It is expected that those portions of the Executive Control function, concerned with the execution of operational functions and related I/O operations, will remain permanently in primary storage. Occasional executive functions, such as reliability mode control, recovery routines, etc., may or may not be allocated permanently in primary storage. The exact size of the Executive Control function is determined by the design of a data processing organization appropriate to a specific CCC hardware configuration. Since the storage requirements of the Executive Control function of the experimental system would not be significant for the CCC, this data is omitted from the tables. The bidder must estimate and include this functional storage requirement in accordance with the instructions given him in this specification (see Appendix F).
- (f) Next Function Environment.- The storage allocated to the next function to be executed may vary from zero, with attendant operating time penalty incurred as a result of waiting until the next function and its environment are transferred into primary storage, to the totality of remaining programs and tables, if a choice is made to substitute primary storage for all bulk storage. This data is not given for the experimental system since it would not be meaningful for the system design chosen for the CCC.
- (g) Bulk Storage.- The Bulk Storage requirement should be determined as a result of trade-offs among I/O time, primary storage, and bulk storage.

1.2 Input/Output Transfers (Tables B-2a, b, and c).- Certain I/O transfers are mandatory as a result of system peripheral devices and recording requirements. Other I/O transfers, specifically to and from bulk storage, are design options dependent on trade-offs among primary storage, bulk storage, and I/O time. Data is presented for both types of transfer.

- (a) Peripheral Data.- For every listed function, the amount of peripheral data which must be transferred in or out is listed. The size of the data block is based on a 32-bit word, and may be assumed to be inversely proportional to word length.

This data from the experimental system is based on the existence of external drum buffers for all system peripheral devices. Data to permit consideration of alternate approaches is presented in section 3.4.

- (b) Recorded Data.- The stated amount of data must be transferred from primary storage to magnetic tape or other bulk storage medium after the function has been completed to satisfy safe data and legal recording requirements. The size of the data block is based on a 32-bit word and may be assumed to be inversely proportional to word length.
- (c) Program Transfer.- As a design option, any or all programs may be transferred from bulk storage into primary storage for execution. Required program length may be adjusted if it can be shown that the proposed CCC has a more effective instruction repertoire than that of the experimental system processor (see Appendix A).
- (d) Data Tables-Transfer In.- As a design option, any or all data tables may be transferred from bulk storage into primary storage for execution of a given function. The sequence of functions will determine which tables may remain in primary storage from the execution of one function to the next. Exercising the option to execute a function in several passes will imply several (smaller) data table transfers per function. Data tables are based on a 32-bit word, and their length may be assumed to be inversely proportional to word length.
- (e) Data Tables-Transfer Out.- Data tables that are transferred in and modified must subsequently be transferred out. For transfer purposes, it is assumed that a data table is modified in its entirety even though data for certain flights may remain unchanged.

1.3 Timing Data (Tables B-3a, b, and c).- The effective computing speed of the proposed CCC must guarantee that the cycle for the given traffic demand can be completed in 2.5 seconds.

- (a) Computing Time Per Cycle.- The computing time required for every function is approximated with a single expression. This computing time does not account for any transfer time requirements, nor does it account for the effect of transfers on computing speed. The computing time is referenced to 80,000 operations per second (see Appendix A).

Any function that is processed in several passes (i.e., several successive operations on subsets of the total flights within a single cycle) should be assumed to require no additional overhead computing time. The computing time per pass should be derived from the expression in the table that states the time as a function of flight load.

- (b) Non-overlapped Transfer Time.- Non-overlapped I/O time, including "break-in" memory cycles, must be accounted for so that the 2.5 second cycle time is not exceeded. The amount of this time will depend on trade-offs among primary storage, bulk storage, and I/O capability.
- (c) Executive Control.- The portion of the Executive Control operating time allocable to a specific function is not given for the experimental system but must be estimated in accordance with the data in this specification and the results must be included in the operating time requirement.

1.4 Legend For Tables (325 flight configuration)

n = number of controlled flights.

Shared Data Tables (32-bit words)

A = 96n	D = 10n
A ₁ = 37n	D ₁ = 1n
A ₂ = 19n	D ₂ = 2n
A ₃ = 24n	D ₃ = 3n
A ₄ = 9n	D ₄ = 2n
B = 58n (total)	E = 600 + 4n
B ₁ = 34n	F = 5n
C = 46n	F ₁ = 2n
C ₁ = 12n	G = 5n
C ₂ = 5n	H = 800
C ₃ = 5n	I = 700
C ₄ = 3n	
C ₅ = 2n	
C ₆ = 8n	
C ₇ = 4n	
C ₈ = 4n	
C ₉ = 2n	

Shared Program Routines (registers)

Y = 500

NOTE: Commas imply "The Sum Of". Time information is stated in milliseconds.

1.5 Explanation of Data in Table B-4--Number and characteristics of External Devices

- (a) Maximum Number of Devices.- The numbers provided in Table B-4 are dependent upon the 100 percent peak load figure, or in the

case of processed radar data and interfacility messages, the maximum number of radars or adjacent facilities which transmit information to the control center. For output of interfacility messages, a common data channel is assumed to connect with each adjacent facility with appropriate addressing of messages.

The data in Table B-4 is based upon 325 flights (n = 325) and a control center configured with 34 control sectors, 8 planning teams, 8 flight data entry positions, 15 search/beacon radars, and 8 adjacent facilities with data channel connection. Each control sector and planning team is equipped with two (2) push-button entry devices, and one (1) alphanumeric keyboard and an on-demand printer. Each planning team is equipped with a high-speed printer. Each search/beacon radar connects to the control center with three data channels to provide sufficient capacity for transmission of processed radar data messages.

- (b) Complete Information Message Length for Each Device.- The number listed in this column of Tables B-4 represents the number of bits or characters which define a single message or that amount of information which must be available to allow complete processing by the appropriate computer program.
- (c) Maximum Transmission Rate of Each Device.- The number listed in this column of Table B-4 is the maximum transmission rate assumed for each of the devices listed.
- (d) Maximum Amount of Information for Each Type of Input or Output for which Buffer Storage (external, internal, or combination) must be Provided During Each 2.5 Second Cycle.- The number listed in this column of Table B-4 is based upon the following:
 - (1) Processed Radar Data

The amount of data which can accumulate in 2.5 seconds if the three channels from each radar are transmitting at the maximum rate.
 - (2) Controller Pushbutton

The amount of information which will have accumulated prior to interpretation if each entry device completes a maximum length message in the same 2.5 second cycle.
 - (3) Alphanumeric Keyboard

The amount of information which will have accumulated prior to interpretation if one-half of the keyboards are permitted simultaneous entry and each of these keyboards completes a maximum length message in the same 2.5 second cycle.

(4) Interfacility Inputs

The amount of information which will have accumulated in 2.5 seconds if each of the adjacent facility channels is transmitting at the maximum rate.

(5) High-speed Printer

The amount of information which $n/100$ printers can accept in 2.5 seconds, each operating at the maximum rate. The $n/100$ printers will be operating simultaneously when the average length of a printout is 150 TTY information words. Each operating printer will generate $n/40$ messages of 15 TTY words each.

(6) On-Demand Printer

The amount of information making up complete messages which must be generated for transmission to $3n/50$ printers, each operating at the maximum rate. The $3n/50$ printers will be operating simultaneously when the demand for printouts peaks at twice the average demand and each printout message averages 17 TTY words of information.

(7) Interfacility Outputs

The maximum amount of information which can be transmitted by the output channel in 2.5 seconds.

- (e) Average Amount of Information Transmitted for Each Type of Input or Output During Each 2.5 Second Cycle.- The numbers listed in this column of Tables B-4, C-4, and D-4 are based upon the average amount of information generated by the environment in which the CCC operates. Each type of input and output is expressed as a function of traffic load, n . With appropriate increase to account for overhead data peculiar to a proposed solution for the peripheral data buffer problem, the numbers in this column will be used to determine peripheral data transfer requirements for all outputs and for any inputs which will be internally buffered.

1.6 Input/Output Transfer and Buffering Approach.- See paragraph 1.6 ff in Appendix C for a discussion of I/O transfers and buffering which is also appropriate for Table B-4.

PRIMARY STORAGE CHART

FLIGHT PLAN PROCESSING

TABLE B- 1a

FUNCTIONS	PROGRAM LENGTH	DATA TABLE STORAGE	WORKING TABLE STORAGE	PERIPHERAL DATA STORAGE	Column Headings for Executive Control, Next Function Environment, and Bulk Storage are omitted
CONTROLLER INPUTS	1800, Y	400, 6n, A ₁ , B ₁ , D ₁ , D ₂ , C ₁ , C ₂ , C ₃ , C ₄ , C ₅ , F, G, I	200	200	
ALPHA NUMERIC INPUTS	13400, Y	6000, A, B, C, H	1100	4300	
FIX-TIME DETERMINATION	2600	400, A, C, F, H	200	--	
FLIGHT PLAN DYNAMICS	3800, Y	300, n, $\frac{1}{2}(A_1, A_2, H),$ $\frac{1}{2}(C_1, C_2, C_3, C_4, C_5)$	200	--	
CONFLICT DETECTION	4400	300, A, C, D, H	1500	--	
ASSOCIATION CHECKING	1200	$\frac{1}{6}(A_1, A_2, F, H),$ $\frac{1}{6}(C_1, C_2, C_3, C_4, C_5)$	200	--	
FLOW CONTROL	1000	$\frac{1}{6}(4n, A, C),$ $\frac{1}{6}(D_1, D_2, D_3,)$	800	--	

PRIMARY STORAGE CHART
SURVEILLANCE PROCESSING
TABLE B - 1b

FUNCTIONS	PROGRAM LENGTH	DATA TABLE STORAGE	WORKING TABLE STORAGE	PERIPHERAL DATA STORAGE	Column Headings for Executive Control, Next Function Environment, and Bulk Storage are omitted
RADAR INPUT PROCESSING	3900	500, E, F, G, I 14000 + 1800	2600	8500	
AUTOMATIC TRACKING	1200	F, G, I 10000 + 700	n	---	
PROXIMITY WARNING	600	n, $\frac{1}{2}(D_1, F_1)$	--	--	

PRIMARY STORAGE CHART
OUTPUT PROCESSING

TABLE B - 1C

FUNCTIONS	PROGRAM LENGTH	DATA TABLE STORAGE	WORKING TABLE STORAGE	PERIPHERAL DATA STORAGE	Column Headings for Executive Control, Next Function Environment, and Bulk Storage are omitted
PLAN POSITION DISPLAY GENERATION	6600	1000, 2n, C ₁ , C ₂ , C ₃ , C ₄ , C ₅ , E, F, H	800, n	23n	
TABULAR DISPLAY GENERATION	5000	$\frac{4}{3}(A_1, A_2, A_3),$ $\frac{1}{3}(B, C, F)$	800	2n	
ON DEMAND PRINTER OUTPUTS	3300	1300, 3n, A ₁ , A ₅ , B, C ₁ , C ₃ , C ₆ , C ₈ , D ₂ , D ₄	800	2n	
AUTOMATIC PRINTER OUTPUTS	3300	3n, A ₁ , A ₂ , A ₃ , B, C, F	1200	3n	
INTERFACILITY OUTPUTS	3000	19n, B	400	n	

INPUT/OUTPUT TRANSFERS
FLIGHT PLAN PROCESSING

TABLE B - 2a

FUNCTIONS	MANDATORY TRANSFERS			DESIGN OPTIONS		
	PERIPHERAL DATA	RECORDED DATA	PROGRAM TRANSFER	DATA TABLES TRANSFER IN	DATA TABLES TRANSFER OUT	
CONTROLLER INPUTS	200	200, n	1800, Y	400, 6n, A ₁ , B ₁ , D ₁ , D ₂ , C ₁ , C ₂ , C ₃ , C ₄ , C ₅ , F, G, I	6n, D ₁ , D ₂ , F, G, I, C ₁ , C ₂ , C ₃ , C ₄ , C ₅	
ALPHA-NUMERIC INPUTS	4300	100, 0.08A, 0.17B, 0.04C	13400, Y	6000, A, B, C, H	1400, A, B, C	
FIX-TIME DETERMINATION	--	n	2600	400, A, C, F, H	A, C, F	
FLIGHT PLAN DYNAMICS	--	0.25(A ₁ , A ₂), 0.25(C ₁ , C ₂ , C ₃ , C ₄ , C ₅)	3800, Y	300, n, 1/2(A ₁ , A ₂ , H), 1/2(C ₁ , C ₂ , C ₃ , C ₄ , C ₅)	n, 1/2(A ₁ , A ₂), 1/2(C ₁ , C ₂ , C ₃ , C ₄ , C ₅)	
CONFLICT DETECTION	--	D	4400	300, A, C, D, H	C ₂ , C ₃ , C ₇ , C ₈ , D	
ASSOCIATION CHECKING	--	n	1200	300, 1/6(A ₁ , A ₂ , F, H), 1/6(C ₁ , C ₂ , C ₃ , C ₄ , C ₅)	1/6(A ₂ , F), 1/6(C ₁ , C ₂ , C ₃ , C ₄ , C ₅)	
FLOW CONTROL	--	n	1000	300, 1/6(4n, A, C), 1/6(D ₁ , D ₂ , D ₃)	1/6(4n)	

INPUT/OUTPUT TRANSFERS
SURVEILLANCE PROCESSING
TABLE B - 2b

FUNCTIONS	MANDATORY TRANSFERS		DESIGN OPTIONS		
	PERIPHERAL DATA	RECORDED DATA	PROGRAM TRANSFER	DATA TABLES TRANSFER IN	DATA TABLES TRANSFER OUT
RADAR INPUT PROCESSING	8500	1400, I	3900	500, E, F, G, I	500, E, F, G, I
AUTOMATIC TRACKING	--	F, G	1200	F, G, I	F, G, I
PROXIMITY WARNING	--	n	600	n, $\frac{1}{2}(D_1, F_1)$	n

INPUT/OUTPUT TRANSFERS
OUTPUT PROCESSING

FUNCTIONS	MANDATORY TRANSFERS		DESIGN OPTIONS		
	PERIPHERAL DATA	RECORDED DATA	PROGRAM TRANSFER	DATA TABLES TRANSFER IN	DATA TABLES TRANSFER OUT
Plan Position Display Generation	23n	n	6600	1000, 2n, C1, C2, C3, C4, C5, E, F, H	1000, 2n, C1, C2, C3, C4, C5, E
Tabular Display Generation	2n	2n	5000	1/3(A1, A2, A3), 1/3(B, C, F)	1/3(C1, C2, C4, C6, C7, C9), 1/3F
On-Demand Printer Outputs	n	n	3300	1300, 3n, A4, A5, B, C1, C3, C6, C8, D2, D4	D2, D4
Automatic Printer Outputs	3n	n	3300	3n, A1, A2, A3, B, C, F	3n, C3, C4, C8, C9
Interfacility Outputs	n	2n	3000	19n, B	-----

TABLE B-3a

TIMING DATA

FLIGHT PLAN PROCESSING

FUNCTIONS	COMPUTING TIME PER CYCLE(MS)	TRANSFER TIME		EXECUTIVE CONTROL
		TOTAL	NON-OVERLAPPED	
Controller Inputs	12,0.18n			
Alphanumeric Inputs	1.8n			
Fix-Time Determination	0.5n			
Flight Plan Dynamics	4.45n			
Conflict Detection	11n			
Association Checking	2.5,0.06n <i>17.95</i>			
Flow Control	0.17n			

TABLE B-35

TIMING DATA

SURVEILLANCE PROCESSING

FUNCTIONS	COMPUTING TIME PER CYCLE	TRANSFER TIME		EXECUTIVE CONTROL
		TOTAL	NON-OVERLAPPED	
Radar Input Processing	2.3n			
Automatic Tracking	2.0n			
Proximity Warning	13,0.05n			
	(milli.sec.)			

TABLE B-3c

TIMING DATA
OUTPUT PROCESSING

FUNCTIONS	COMPUTING TIME PER CYCLE	TRANSFER TIME		EXECUTIVE CONTROL
		TOTAL	NON-OVERLAPPED	
Plan Position Display Generation	4.3n			
Tabular Display Generation	0.67n			
On-Demand Printer Outputs	0.4n			
Automatic Printer Outputs	1.0n			
Interfacility outputs	0.1n			
	(millisec.)			

EXTERNAL DEVICE OR CHANNEL	MAXIMUM NUMBER OF DEVICES	COMPLETE INFORMATION MESSAGE LENGTH FOR EACH DEVICE	MAXIMUM TRANS-MISSION RATE OF EACH DEVICE	MAXIMUM AMOUNT OF INFORMATION** FOR EACH TYPE OF INPUT OR OUTPUT FOR WHICH BUFFER STORAGE (ENTIRE, PARTIAL, OR CONTINUATION) MUST BE PROVIDED DURING EACH 2.5 SECOND CYCLE	AVERAGE AMOUNT OF INFORMATION TRANSMITTED FOR EACH TYPE OF INPUT OR OUTPUT DURING EACH 2.5 SECOND CYCLE
<u>INPUT</u> Processed Radar Data (for example, phone line data link) Controller Pushbutton (for example, 10 modules of 10-15 pushbuttons each) Alphanumeric Keyboard (for example, Teletypewriter) Interfacility (for example, phone line data link)	15 ASR's and ASR's 68 42 8	53-79 bits 12-48 bits 2-30 TTY* wds (7 TTY wds avg) 2-30 TTY* wds (5 TTY wds avg)	2400 bits/sec per channel or 7200 bits/sec maximum 1 msg/2.5 second cycle 100 TTY* wds/min 2400 bits/sec	270×10^3 bits 3.3×10^3 bits 630 TTY* words 48×10^3 bits	$0.1n \times 10^3$ bits n bits $0.04n$ TTY* words 2n bits
<u>OUTPUT</u> High-Speed Printer On-Demand Printer (for example, Teletypewriter) Interfacility (for example, phone line data link)	7 42 1	10-30 TTY* wds (15 TTY* wds avg) 2-96 TTY* wds (17 TTY* wds avg) 2-30 TTY* wds (5 TTY* wds avg)	3600 TTY* wds/min 100 TTY* wds/min 2400 bits/sec	$\left[\frac{n}{120} \right] \frac{3600}{24} = \frac{3}{2} n$ TTY* words $\left[\frac{n}{50} \right] \frac{12}{24} = \frac{1}{2} n$ TTY* words $\left[\frac{n}{100} \right] \frac{100}{24} = \frac{1}{24} n$ TTY* words 6×10^3 bits	$\left[\frac{n}{120} \right] \frac{3600}{24} = \frac{3}{4} n$ words $\left[\frac{n}{100} \right] \frac{100}{24} = \frac{n}{24}$ TTY* words 2n bits

**Buffer table capacity exceeds channel capacity to permit reasonable message queue.

*May be same as Radar Controller Keyboard (see Tables C-4 and D-4).

NUMBER AND CHARACTERISTICS OF EXTERNAL DEVICES - 325 Flight Configuration
Table B-4

*Teletypewriter (TTY) word = five 6-bit information characters
**Depending upon the characteristics of the Peripheral Device Adapter additional storage for data used to control the addressing and timing of outputs may be needed.

APPENDIX CDATA PROCESSING TABLES FOR THE 200 FLIGHT CONFIGURATION

1. Description of Data Contained in Tables.- The following paragraphs describe the data contained in each column of the data processing tables that are included in this appendix.

1.1 Primary Storage (Tables C-1a, b, and c).- The descriptive comments on Primary Storage in paragraph 1.1, items (a) through (g), of Appendix B are applicable here. The legend for this appendix appears in paragraph 1.4.

1.2 Input/Output Transfers (Tables C-2a, b, and c).- The descriptive comments on Input/Output Transfers in paragraph 1.2, items (a) through (e), of Appendix B are applicable here. See legend in paragraph 1.4.

1.3 Timing Data (Tables C-3a, b, and c).- The descriptive comments on Timing Data in paragraph 1.3, items (a) through (c), of Appendix B are applicable here. See legend in paragraph 1.4.

1.4 Legend for Tables (200 flight configuration)

Dynamic Tables (n = number of controlled flights)

A = 18n
 B = 63n
 B₁ = 5n
 B₂ = 44n
 C = 21n
 C₁ = 7n
 C₂ = 10n
 E = 4n+600
 F = 5n
 F₁ = n
 G = 6n
 H = 300
 I = 700

NOTE: Commas imply "The Sum Of". Time information is stated in milliseconds.

1.5 Number and Characteristics of External Devices.- So that alternative solutions to the peripheral data storage and transfer problem can be considered for the 200 flight configuration, Table C-4 summarizes the number and data characteristics of individual external devices by type. The plan-position displays are excluded from this summary since it is assumed that the display generation will involve the use of external buffers.

The following describes the information provided in Table C-4 for each type of peripheral data input and output.

- (a) Maximum Number of Devices.- The number provided is dependent upon the 100 per cent peak load figure; or in the case of processed radar data and inter-facility messages, the maximum number of radars or adjacent facilities which transmit information to the control center. For output of inter-facility messages, a common data channel is assumed to connect each adjacent facility with appropriate addressing of messages.

The data in Table C-4 is based upon 100 per cent peak load of 200 flights (n = 200) and control center configured with 34 radar control positions, 34 sector controllers, 10 Flight Data Entry positions, 8 search/beacon radars, and 6 adjacent facilities with data channel connection. Each radar control position is equipped with one (1) radar controller keyboard, and each sector control position is equipped with one (1) computer update entry device, one (1) flight strip printer, and one (1) flight strip update display device. Each search/beacon radar connects to the control center with three data channels to provide sufficient capacity for transmission of processed radar data messages.

- (b) Complete Information Message Length for Each Device.- The number listed in this column of Table C-4 represents the number of bits or characters which define a single message or that amount of information which must be available to allow complete processing by the appropriate computer program.
- (c) Maximum Transmission Rate of Each Device.- The number listed in this column of Table C-4 is the maximum transmission rate assumed for each of the devices listed.
- (d) Maximum Amount of Information for Each Type of Input or Output for Which Buffer Storage (external, internal, or combination) Must Be Provided During Each 2.5 Second Cycle.- The number listed in this column of Table C-4 is based upon the following:

- (1) Processed Radar Data.- The amount of data which can accumulate in 2.5 seconds if the three channels from each radar are transmitting at the maximum rate.
- (2) Radar Controller Keyboard.- The amount of information which will have accumulated prior to interpretation if each entry device completes a maximum length message in the same 2.5 second cycle.
- (3) Alphanumeric Keyboard Inputs.- The amount of information which will have accumulated prior to interpretation if all the key-boards are permitted simultaneous entry and each of the key-boards completes a maximum length message in the same 2.5 second cycle.
- (4) Computer Update Entry Device.- The amount of information which will have accumulated prior to interpretation if all the entry devices are permitted simultaneous entry and a maximum length message is completed with each of the devices in the same 2.5 second cycle.
- (5) Inter-facility Inputs.- The amount of information which will have accumulated in 2.5 seconds if each of the adjacent facility channels is transmitting at the maximum rate.
- (6) Flight Strip Printer.- The amount of information making up complete flight strips which must be generated for transmission to $\lceil n/90 \rceil$ printers, each operating at the maximum rate. $\lceil n/90 \rceil$ printers will be operating simultaneously when the demand for printing flight strips peaks at twice the average demand and each strip averages 120 characters of information.
- (7) On-Demand Printer.- The amount of information making up complete messages which must be generated for transmission to $\lceil 0.20n \rceil$ printers, each operating at the maximum rate. The $\lceil 0.02n \rceil$ printers will be operating simultaneously when the demand for printouts peaks at twice the average demand and each printout message averages 70 characters of information.
- (8) Flight Strip Update Display.- The amount of information making up complete displays which must be generated for transmission if an output is demanded for each display in the same 2.5 second cycle.
- (9) Inter-facility Outputs.- The maximum amount of information which can be transmitted by the output channel in 2.5 seconds.

- (e) Average Amount of Information Transmitted for Each Type of Input or Output During Each 2.5 Second Cycle.- The number listed in this column of Table C-4 is based upon the average amount of information generated by the environment in which the CCC operates. Each type of input and output is expressed as a function of traffic load, n. With appropriate increase to account for overhead data peculiar to a proposed solution for the peripheral data buffer problem, the number in this column will be used to determine peripheral data transfer requirements for all outputs and for any inputs which will be internally buffered.

1.6 Input/Output Transfer and Buffering Approach.- The number and type of external devices are assumed to be constant with respect to traffic load, hence all maximum requirements for input buffer storage are treated as being independent of the traffic load, n. Except for inter-facility outputs, all maximum requirements for output buffer storage are proportional to traffic load. Demand for outputs in excess of the peak amount provided for would be serviced as capacity becomes available.

1.6.1 Since each function will be executed only once per 2.5 second cycle and most inputs/outputs will be batch processed, every solution to the peripheral data buffer problem must provide for the maximum amount of information listed in Table C-4 whether this storage is provided internally in primary memory, externally on drums or other storage media, or in some combination.

1.6.2 Information storage may be only a part of the total buffer storage required. The characteristics of a proposed buffer system and related logic may require additional storage for data used to control the addressing and timing of outputs, and to tag the source of input data on less than a complete message basis. For example, the drum buffering sub-system of the experimental ATC system allows for storage of four 6-bit information characters of high-speed and on-demand printer outputs for each 32-bit computer word. Provision must be made for storing the overhead data as well as information data in any solution to the peripheral data storage and transfer problem.

1.6.3 The entry in Table C-1 for peripheral data storage associated with any function is the sum of the maximum amount of information required to be buffered during a 2.5 second cycle (from Table C-4) and the overhead data associated with that information.

1.6.4 In addition, since Table C-2 is based upon an approach to buffering where all inputs are entirely externally buffered, the entry for Mandatory Transfer Peripheral Data associated with any function is also the sum of the maximum amount of information required to be buffered during a 2.5 second cycle (from Table C-4) and the overhead data associated with that information. For outputs, and for inputs in the case where inputs are internally buffered, the Mandatory Transfer Peripheral Data entry of Table C-2 would be the average amount of information plus associated overhead data transmitted for each type of input or output during each 2.5 second cycle.

PRIMARY STORAGE CHART SURVEILLANCE PROCESSING									
FUNCTIONS	PROGRAM LENGTH	DATA TABLE STORAGE	WORKING TABLE STORAGE	PERIPHERAL DATA STORAGE	EXECUTIVE CONTROL	NEXT FUNCTION ENVIRON.	BULK STORAGE		
CONTROLLER INPUTS	1800	400, 2n, C ₂ , F, G, I	—	300					
RADAR INPUTS	3700	400, n, E, F, G, I	2000	4500					
TRACKING	1300	n, F, G	n	—					

TABLE C-1b

PRIMARY STORAGE CHART									
OUTPUT PROCESSING									
FUNCTIONS	PROGRAM LENGTH	DATA TABLE STORAGE	WORKING TABLE STORAGE	PERIPHERAL DATA STORAGE	EXECUTIVE CONTROL	NEXT FUNCTION ENVIRON.	BULK STORAGE		
PLAN POSITION DISPLAYS	4600	1600, n, C, E, F	200	17n					
ON-DEMAND PRINTER	2900	200, 2n, B, C ₂	200	n					
STRIP PRINTING AND UPDATING	1200	200, n, B	200	3n					
INTER-FACILITY OUTPUTS	900	2n, B, C	200	n					

TABLE C-1c

INPUT/OUTPUT TRANSFERS										
FLIGHT PLAN PROCESSING										
FUNCTIONS	MANDATORY TRANSFERS		PROGRAM TRANSFER	DESIGN OPTIONS		DATA TABLES TRANSFER IN	DATA TABLES TRANSFER OUT			
	PERIPHERAL DATA	RECORDED DATA		TRANSFER IN	TRANSFER OUT					
ALPHA-NUMERIC INPUTS	3100	100, 0.17B, 0.04C.	9200	3200, A, B, C, H	800, A, B, C					
FIX-TIME COMPUTATION	—	n, (A, C)	4200	400, n, A, B, C, F, H	A, B, C					

TABLE C-2a

INPUT/OUTPUT TRANSFERS SURVEILLANCE PROCESSING										
FUNCTIONS	MANDATORY TRANSFERS		PROGRAM TRANSFER	DESIGN OPTIONS		DATA TABLES TRANSFER IN	DATA TABLES TRANSFER OUT			
	PERIPHERAL DATA	RECORDED DATA		DATA TABLES TRANSFER IN	DATA TABLES TRANSFER OUT					
CONTROLLER INPUTS	300	300, n	1800	400, 2n, C ₂ , F, G, I	200, 2n, C ₂ , F, G, I					
RADAR INPUTS	4500	500, I	3700	400, n, E, F, G, I	300, E, F, G, I					
TRACKING	—	F, G,	1300	n, F, G	F, G					

TABLE C-2b

INPUT/OUTPUT TRANSFERS OUTPUT PROCESSING										
FUNCTIONS	MANDATORY TRANSFERS		PROGRAM TRANSFER	DESIGN OPTIONS		DATA TABLES TRANSFER IN	DATA TABLES TRANSFER OUT			
	PERIPHERAL DATA	RECORDED DATA		DATA TABLES TRANSFER IN	DATA TABLES TRANSFER OUT					
PLAN POSITION DISPLAY	17n	n	4600	1600,n, C,E,F	1200, n,C1,E					
ON-DEMAND PRINTER	n	n	2900	200,2n, B,C2	n					
STRIP PRINTING AND UPDATING	n	n	1200	200,n, B	n					
INTER-FACILITY OUTPUTS	n	2n	900	2n,B, C	n					

TABLE C-2

EXTERNAL DEVICE OR CHANNEL	MAXIMUM NUMBER OF DEVICES	COMPLETE INFORMATION MESSAGE LENGTH FOR EACH DEVICE	MAXIMUM TRANS-MISSION RATE OF EACH DEVICE	MAXIMUM AMOUNT OF INFORMATION** FOR EACH TYPE OF INPUT OR OUTPUT FOR WHICH BUFFER STORAGE (EXTERNAL, INTERNAL, OR COMBINATION) MUST BE PROVIDED DURING EACH 2.5 SECOND CYCLE	AVERAGE AMOUNT OF INFORMATION TRANSMITTED FOR EACH TYPE OF INPUT OR OUTPUT DURING EACH 2.5 SECOND CYCLE
<u>INPUT</u>					
Processed Radar Data (for example, phone line data link)	8 ASRT's	53-79	2400 bits/sec per channel or 7200 bits/sec maximum	144×10^3 bits	$0.1n \times 10^3$ bits
Radar Controller Keyboard (for example, Hazeltine Functional Control Panel)	34	6-24 char	200 char/min	900 char	0.3n char
Alphanumeric Keyboard Teletypewriter (for example, send part of 28ASR)	10	10-150 char (70 char avg)	100 TTY* vds/min	1500 char	0.2n char
Computer Update Equipment (CUE)	34	16 char	200 char/min	600 char	0.1n char
Interfacility (for example, phone line data link)	6	10-150 char (17 char avg)	2400 bits/sec	36×10^3 bits	$0.3n$ char
<u>OUTPUT</u>					
Flight Strip Printer (for example, Kleinschmidt Printer)	34	50-400 char (120 char avg)	40 char/sec	$\left[\frac{n}{90} \right] 140$ char $\approx \frac{2n}{2}$ char	0.7n char
On-Demand Printer (for example, receive part of 28ASR)	10	10-400 char (70 char avg)	100TTY* vds/min	$\left[0.02n \right] 45 \approx n$ char***	0.2n char
Flight Strip Update Display (for example, CUE readout)	34	4-17 char (10 char avg)	200 char/sec	600 char	0.2n char
Interfacility (for example, phone line data link)	1	10-150 char (17 char avg)	2400 bits/sec	6×10^3 bits	$0.3n$ char

*Teletypewriter (TTY) word = five 6-bit information characters.

**Depending upon the characteristics of the Peripheral Device Adapter additional storage for data used to control the addressing and timing of outputs may be needed.

***Buffer table capacity exceeds channel capacity to permit reasonable message queue.

NUMBER AND CHARACTERISTICS OF EXTERNAL DEVICES - 200 Flight Configuration
Table G-4

APPENDIX DDATA PROCESSING TABLES FOR THE 100 FLIGHT CONFIGURATION

1. Description of Data Contained in Tables.- The following paragraphs describe the data contained in each column of the data processing tables which are included in this appendix.

1.1 Primary Storage (Tables D-1a, and b).- The descriptive comments on Primary Storage in paragraph 1.1, items (a) through (g), of Appendix B are applicable here. The legend for these tables appears in paragraph 1.4 of this appendix.

1.2 Input/Output Transfers (Tables D-2a, and b).- The descriptive comments on Input/Output Transfers in paragraph 1.2, items (a) through (e), of Appendix B are applicable here. See legend in paragraph 1.4.

1.3 Timing Data (Tables D-3a, and b).- The descriptive comments on Timing Data in paragraph 1.3, items (a) through (c), of Appendix B are applicable here. See legend in paragraph 1.4.

1.4 Legend for Tables (100 flight configuration)

Dynamic Tables (n = number of controlled flights)

$$\begin{aligned} B &= 5n \\ C &= 5n \\ C_1 &= 2n \\ C_2 &= 3n \\ E &= 4n+600 \\ F &= 5n \\ G &= 6n \\ I &= 700 \end{aligned}$$

NOTE: Commas imply "The Sum Of". Time information is stated in milliseconds.

1.5 Number and Characteristics of External Devices.- So that alternative solutions to the peripheral data storage and transfer problem can be considered for the 100 flight configuration, Table D-4 summarizes the number and data characteristics of individual external devices by type. The plan-position displays are excluded from the summary since it is assumed that display generation will involve the use of external buffers.

The following describes the information provided in Table D-4 for each type of peripheral data input and output:

- (a) Maximum Number of Devices.- The number provided is dependent upon the 100 percent peak load figure; or in the case of processed radar data and inter-facility messages, the maximum number of radars or adjacent facilities which transmit information to the terminal control facility.

The data in Table D-4 is based upon a 100 percent peak load of 100 flights (n = 100) and a terminal control facility configured with 17 radar control positions, 3 supervisory data entry/output stations, 3 short-range search/beacon radar, and one long-range search/beacon radar, and one adjacent center with data channel connection. Each radar control position is equipped with one (1) radar controller keyboard. Each supervisory data output station is equipped with an on-demand printer. The radar video processor for each sort-range search/beacon radar is located in the terminal control facility. The long-range search/beacon radar connects to the facility with three data channels to provide sufficient capacity for transmission of processed radar data messages.

- (b) Complete Information Message Length for Each.- The number listed in this column of Table D-4 represents the number of bits or characters which define a single message or that amount of information which must be available to allow complete processing by the appropriate computer program.
- (c) Maximum Transmission Rate of Each Device.- The number listed in this column of Table D-4 is the maximum transmission rate assumed for each of the devices listed.
- (d) Maximum Amount of Information for Each Type of Input or Output For Which Buffer Storage (external, internal, or combination) Must Be Provided During Each 2.5 Second Cycle.- The number listed in this column of Table D-4 is based upon the following:

(1) Processed Radar Data

For the long-range search/beacon radar, the amount of data which can accumulate in 1.25 seconds if the three channels from each radar are transmitting at the maximum rate. For the short-range search/beacon radars, the amount of data which can accumulate in 1.25 seconds if each of the radar video data processors

are handling data of their maximum capacity. It should be noted that radar inputs processing is assumed to operate twice in each 2.5 second cycle, hence the buffer requirements is for that amount of data which accumulated in 1.25 seconds.

(2) Radar Controller Keyboard

The amount of information which will have accumulated prior to interpretation if each entry device completes a maximum length message in the same 2.5 second cycle.

(3) Interfacility Inputs

The amount of information which will have accumulated in 2.5 seconds if each of the adjacent facility channels is transmitting at the maximum rate.

(4) Supervisory Data Output Printer

The amount of information making up complete supervisory printouts which must be generated for transmission to three printers, each operating simultaneously at the maximum rate.

(5) Interfacility Outputs

The amount of information which will have accumulated in 2.5 seconds if each of the adjacent facility channels is transmitting at the maximum rate.

- (e) Average Amount of Information Transmitted for Each Type of Input or Output During Each 2.5 Second Cycle.- The number listed in this column of Table D-4 is based upon the average amount of information generated by the environment in which the CCC operates. Each type of input and output is expressed as a function of traffic load, n. With appropriate increase to account for overhead data peculiar to a proposed solution for the peripheral data buffer problem, the number in this column will be used to determine peripheral data transfer requirements for all outputs and for any inputs which will be internally buffered.

1.6 Input/Output Transfer and Buffer Approach.- The number and type of external devices are assumed to be constant with respect to traffic load, hence all maximum requirements for input buffer storage are treated as being independent of the traffic load, n. Except for interfacility outputs, all maximum requirements for output buffer storage are proportional to

traffic load. Demand for outputs in excess of the peak amount provided for would be serviced as capacity becomes available.

1.6.1 Since each function will be executed only once per 2.5 second cycle* and most inputs/outputs will be batch processed, every solution to the peripheral data buffer problem must provide for the maximum amount of information listed in Table D-4 whether this storage is provided internally in primary memory, externally on drums, or other storage media, or in some combination.

1.6.2 Information storage may be only a part of the total buffer storage required. The characteristics of a proposed buffer system and related logic may require additional storage for data used to control the addressing and timing of outputs, and to tag the source of input data on less than a complete message basis. For example, the drum buffering sub-system of the experimental ATC system allows for storage of four 6-bit information characters of alphanumeric keyboard inputs, and only two 6-bit information characters of high-speed and on-demand printer outputs for each 32-bit computer word. Provision must be made for storing the overhead data as well as information data in any solution to the peripheral data storage and transfer problem.

1.6.3 The entry in Table D-1 for peripheral data storage associated with any function is the sum of the maximum amount of information required to be buffered during a 2.5-second cycle (from Table D-4) and the overhead data associated with that information. In addition, since Table D-2 is based upon an approach to buffering where all inputs are entirely externally buffered, the entry for mandatory transfers-peripheral data associated with any function is also the sum of the maximum amount of information required to be buffered during a 2.5-second cycle (from Table D-4, and the overhead data associated with that information). For outputs and for inputs in the case where inputs are internally buffered, the mandatory transfer-peripheral data entry of Table D-2 would be the average amount of information plus associated overhead data transmitted for each type of input or output during each 2.5-second cycle.

*With the exceptions of Processed Radar Data-Short-Range Inputs and Long-Range Inputs which are shown on Table D-4 as being processed twice each 2.5 second cycle.

INPUT/OUTPUT TRANSFERS										
INPUT AND SURVEILLANCE PROCESSING										
FUNCTIONS	MANDATORY TRANSFERS		PROGRAM TRANSFER	DESIGN OPTIONS			DATA TABLES TRANSFER OUT			
	PERIPHERAL DATA	RECORDED DATA		TRANSFER IN	DATA TABLES	TRANSFER OUT				
CONTROLLER INPUTS	100	100, n	1200	100, B, C, F, G	B, C, F, G					
RADAR INPUT PROCESSING	1300	700, I	3900	400, n, E, F, G, I	E, F, G, I					
AUTOMATIC TRACKING	—	F, G	900	n, F, C	n, F, G					

TABLE D-2a

INPUT OUTPUT TRANSFERS										
OUTPUT PROCESSING										
FUNCTIONS	MANDATORY TRANSFERS		PROGRAM TRANSFER	DESIGN OPTIONS		DATA TABLES TRANSFER IN	DATA TABLES TRANSFER OUT			
	PERIPHERAL DATA	RECORDED DATA								
PLAN POSITION DISPLAY GENERATION	15n	n	2200	C,E,F, n,200	C ₂ , n					
ON-DEMAND PRINTER	n	n	1900	B,C,F, n,200	n					
INTER-FACILITY	n	n	300	C,F,n	n					

TABLE D-2b

EXTERNAL DEVICE OR CHANNEL	MAXIMUM NUMBER OF DEVICES	COMPLETE INFORMATION MESSAGE LENGTH FOR EACH DEVICE	MAXIMUM TRANSMISSION RATE OF EACH DEVICE	MAXIMUM AMOUNT OF INFORMATION** FOR EACH TYPE OF STORAGE (EXTERNAL, INTERNAL, OR COMBINATION) MUST BE PROVIDED DURING EACH 2.5 SEC. CYCLE	AVERAGE AMOUNT OF INFORMATION TRANSMITTED FOR EACH TYPE OF INPUT OR OUTPUT DURING EACH 2.5 SECOND CYCLE
<u>INPUT</u>					
Processed Radar Data	3 ASR's	53-79 bits	2400 bits/sec per channel or 7200 bits/sec maximum	27 x 10 ³ bits*	0.2n x 10 ³ bits
Short-Range Inputs (for example, DOG of RWDP-2 or -3.)	1 ARSR	53-79 bit	2400 bits/sec per channel or 7200 bits/sec maximum	9 x 10 ³ bits*	
Long-Range Inputs (for example, phone line data link)	17	6-24 char	200 char/min	410 char	0.3n char
Radar Controller Keyboard (for example, Hazeltine Functional Control Panel.)	1	10-15 char (11 char avg)	2400 bits/sec	6 x 10 ³ bits	0.1n char
Interfacility (for example, phone line data link)					
<u>OUTPUT</u>					
Interfacility (i.e., phone line data link)	1	10-15 char (11 char avg)	2400 bits/sec	6 x 10 ³ bits	0.1n char
Supervisory Data Output Printer	3	7 char	500 char/min	100 char	negligible

NUMBER AND CHARACTERISTICS OF EXTERNAL DEVICES - 100 Flight Configuration

Table D-4

*These inputs may be processed twice every 2.5 sec. cycle, hence the amount of data to be stored in the buffer is shown as 1/2 the maximum amount of data to be processed in a 2.5 sec. cycle.

**Depending upon the characteristics of the Peripheral-Device Adapters additional storage for data used to control the addressing and timing of outputs may be needed.

APPENDIX EDESCRIPTION OF DATA-PROCESSING FUNCTIONS

This appendix provides a summary description of the data-processing functions that would be required in a typical air traffic control center. This information is intended to permit a better understanding of the requirements of Section 3.3 of the specification. The descriptions are divided into the same areas as Section 3.3; i.e., Flight Plan Data Processing, Surveillance Data Processing, Output Data Processing, and Executive Control.

1. Flight Plan Data-Processing Area.- This section describes those functions which operate on or modify flight plan data. Typical flight plan data includes: aircraft identification, aircraft type, speed, origin of flight, time of departure, route, altitude over various portions of route, fix points, estimated time of arrival over fix points, destination, alternate destinations, etc.

1.1 Controller Input Processing.- Each control and planning position will be provided with an input device to permit rapid entry of a number of inputs. Representative examples of these inputs are:

(a) Plan Position Display Requests

- (1) Request display of flights within a specified altitude range.
- (2) Request display of a flight plan route.
- (3) Request suppression or repositioning of alphanumeric information that is displayed at aircraft position.

(b) Printout Requests

- (1) Request detailed conflict information on a flight.
- (2) Request stored flight plan route/time information.

(c) Flight Plan Modification

- (1) Modify assigned altitude.
- (2) Enter holding instructions for a flight plan fix.

(d) Transfer of Control

- (1) Prepare handover. ✓
- (2) Accept handover. ✓
- (3) Assume control. ✓
- (4) Release for the control sector from which transferred. ✓

1.2 Alphanumeric Keyboard Input Processing.- Each control and planning position, as well as local and remote flight data entry positions, will be provided with an alphanumeric keyboard input capability for the direct on-line entry of a variety of inputs. The keyboard for alphanumeric inputs may be separate from input devices for other control inputs. Characteristics of alphanumeric keyboard inputs are:

- (a) Message formats and contents will conform to current air traffic control practices. Fields not applying to a particular message may be omitted, variable-length items will be permitted without padding characters, and a wide latitude will be possible in message sequence, composition, and length. Formats convenient for composition by the controller may require reformatting in the computer.
- (b) Controllers will be able to correct or revise items within a message without repeating the entire message. Each incoming message will be subject to computer program acceptance checking to guard against certain classes of errors not detected or corrected by the controller and to insure that each input represents a complete and coherent message. If an input message is acceptable, a receipt message will be output to the sender. The controller may then proceed with the next input. If a message is not acceptable, a printout indicating the error will be output to the sender. The controller can then enter additional information to correct the original message, following which the corrected message will be acknowledged by a receipt message. This combined operator-input, computer-output cycle will provide a direct, fast-response, two-way communication channel for alphanumeric data entry.
- (c) Air movement data and transfer-of-control messages crosstold automatically from adjacent control facilities will be processed by the alphanumeric keyboard inputs processing function in much the same manner as described above.

1.2.1 Representative Examples of Alphanumeric Inputs Are:

(a) Air Movement Data

- (1) Flight Plans
- (2) Flight Plan Modifications
- (3) Progress Reports
- (4) Prefiled Routes

(b) Environmental Data

- (1) Winds Aloft
- (2) Barometric Pressure

(c) Data Printout Requests

- (1) Detailed Conflict Information on a Flight
- (2) Stored Flight Plan Route/Time Information
- (3) Prefiled Route

1.3 Flight Plan Dynamics.- Flight plan dynamics will consist of a fix time determination function, a flight plan position and extrapolation function, an altitude processing function, and an area responsibility function.

(a) Fix Time Determination.- The fix time determination function will calculate and/or modify time data associated with flight plans. | This function will determine relative time information using filed speed, filed route, and stored wind information. Real times will be computed by the adjustment of stored times based upon entered real time information. / New fix times will be calculated whenever the route or speed is modified and whenever a fix time is entered in a progress report or as a result of an update action. /

(b) Flight Plan Extrapolation.- The extrapolation and position function will determine flight plan previous and next fix, present flight plan position and velocity, and extrapolation status. These items will be derived from stored fix information, will form the basis of current air situation displays, and will provide inputs to the automatic tracking, and to processes associating track with flight plan position.

FP was used for auto tracking

(c) Altitude Processing.- Altitude processing will serve three purposes:

- (1) To describe the intended vertical profile of flight,
- (2) To monitor the conformance of reported altitude

- of a flight with the filed altitude profile, and
- (3) To process the filed data for the convenience of other functions (e.g., conflict detection, plan position display generation).

The altitude processing function will make use of route and altitude data as determined by the alphanumeric input processing function. The output of the function will be used by the conflict detection and plan position display generation functions.

- (d) Area Responsibility.- The area responsibility function will maintain area responsibility based on the geographic division of the control center into sectors, and will generate boundary crossing times. The output of the function will be used by the plan-position display generation function to generate transfer of control displays and to signal the generation and routing of area-sensitive information such as inter-facility messages.

1.4 Conflict Detection.- The conflict-detection process will be based upon flight plan data and will take account of both lateral and longitudinal deviations of an aircraft from predicted positions along a flight plan route. The lateral and longitudinal deviations between actual and predicted position arise from the steering and rate errors inherent in the process of navigating an aircraft along a straight-line route segment. Vertical deviation from predicted position due to accuracy limitations of altimeters will also be accounted for by the conflict detection process.

- (a) To account for these lateral, longitudinal, and vertical deviations, a protected volume of airspace will be circumscribed about the predicted position of each flight plan. It is expected that deviations between predicted and actual flight position will be symmetrical with respect to the predicted position; hence, the protected volume of airspace is defined with the predicted position at the center. Segments of routes represented by areas (holding airspaces and delay areas) will be protected by an appropriate volume of airspace surrounding the area segment for the delay interval. A conflict will exist when the protected volumes of airspace of two flights overlap in the dimensions of space and time.
- (b) The problem of conflict detection will be reduced to a consideration of horizontal space and time dimensions only by processing together only route segments (straight lines and areas) which are within a specified

vertical distance of each other. This specified vertical distance represents an altitude separation standard and accounts for vertical deviations of a flight from its predicted position.

- (c) Route segments involving altitude transitions will be processed with segments of other flights which could occupy the altitude tunnel defined by the transition and the aircraft type involved.
- (d) Conflict detection in the horizontal space-time dimensions will consist of checking for the intersection or overlap of the protected rectangles or delay areas of different flights. ~~The protected rectangle for each flight will have the predicted position as center and will progress in accordance with the times calculated by the fix-time determination process. The length of the protected rectangle along the route segment will be equal to the longitudinal separation standard (minutes of flight). The width of the rectangle will be equal to the lateral separation standard.~~
- (e) Each detected conflict will be described by four items-- a reference time, a duration, a degree of hazard, and the altitude range occupied by each of the flights in conflict in the conflict area.
- (f) Tracks for those flights which are found to be in conflict using flight plan data will be periodically compared for violation of radar separation criteria.

we did

1.5 Association of Track and Flight Plan.- The current track position of a flight and its predicted flight plan position will be compared to measure lateral deviation from filed route and time deviation along the route. An attention indicator will be displayed for a flight whose lateral deviation exceeds a safety margin. Flight plan fix times and predicted position will be tagged for automatic updating by the Flight Plan Dynamics function when the time deviation exceeds a safety margin.

we do

1.6 Flow Control.- Air movements data will be analyzed and summarized to generate tabular displays and/or printouts which will aid the flow controller in predicting system capacity and demand, determine suitable flow control action, and verifying that these actions are effective. These displays will be generated automatically.

2. Surveillance Data Processing Area.- This section describes those functions which depend primarily upon radar and track data.

2.1 Controller Input Processing.- The input device mentioned in 1.1 will also be used for rapid entry of controller input actions associated with surveillance data. Representative examples of these inputs are:

(a) Actions Related to Automatic Tracking

- (1) Start and stop track.
- (2) Change tracking mode.

S, M, L box C₁, C₂, C₃

(b) Plan Position Display Requests

- (1) Request display of beacon codes related to a radar datum.
- (2) Request display of beacon code/call sign for all radar data having the same code filed in a specified flight plan.
- (3) Request display of the area used to associate a track and flight plan position.
- (4) Request suppression or repositioning of alphanumeric information associated with track position.

2.2, Radar Input Processing.- Digitalized radar returns from multiple remote radar sites will be received by the central data processor in polar radar site coordinates. The radar input processing function will transform the polar coordinate data into a common Cartesian coordinate system.

- (a) Selective rejection by sites of redundant data (masking) due to multiple coverage will be performed. Quantity analysis of radar returns by site, system, and type (search or beacon) will be performed to prevent overload of the CCC. Time delays associated with each datum will be delivered to the tracking function.

*Significant
Problem
Rare*

- (b) The quality of radar inputs will be dynamically monitored by examining test messages generated at each of the radar sites and by statistical analysis of the live data. The test messages will be monitored to determine radar data processor and transmission errors. The live data from overlapping radars will be cross-compared to determine system errors in radar orientation, registration, radar beacon collimation, and radar beacon decoding.

2.3 Automatic Tracking.- Automatic tracking will compute positions and velocities for all tracks carried by the system. This includes the automatic processing of radar data, both beacon and search, and flight plan data to obtain position and velocity estimates for each track.

3/0

- (a) The basic tracking function will be performed in three phases:
 - (1) Correlation of radar data with computer tracks.
 - (2) Processing of correlated data, rejecting clutter, detecting turns, etc.
 - (3) Predicting track position and velocity by smoothing operations using previous data on the track and flight plan data.
- (b) Correlation will involve the selective processing of radar data to remove time delays and to determine those data which are most likely to be returns from the track; correlation will be performed using distance measures dependent upon the reliability of past and present returns.
- (c) Processing will be performed on the correlated data to determine the degree to which the return satisfies the conditions of being near the predicted position, and, if the track in replying to beacon interrogations, whether a correct beacon return has been received, etc. The result of the process will be a best estimate of track present position.
- (d) By means of a smoothing operation on track past history, an estimate will be made of track future position, making use of pertinent flight plan data, if necessary.
- (e) If, because of difficulty in receiving data, it becomes impossible to keep a track on its data trail, a tracking trouble detection function will detect the difficulty and will notify the controller in time for him to be able to assess the situation and take corrective action.

2.4 Proximity Warning.- Detected or predicted violation of procedural separation standards using flight plan data implies that a conflict is possible; but, in a radar environment, the violation of radar separation standards is required before a conflict can occur. To detect the imminent violation of radar separation standards, a protected volume of airspace will be defined about the present position of the track of a flight and will be extrapolated for an interval into the future along the expected course of the track.

2.4.1 Periodically, the tracks of all flights in procedural conflict with another track, as determined by the flight plan conflict detection process, will be examined to determine whether there is or will be an overlap of the protected airspace of the track using the radar separation standards. If such an overlap is found, it will be considered an

imminent radar conflict and the information will be displayed to control personnel.

3. Output Data Processing Area.- This section describes the various outputs generated for plan-position and tabular displays, printouts, control data recordings, and inter-facility messages.

3.1 Plan-Position Display Generation.- The plan-position display generation function automatically will make up, format, and tag for routing, output messages for the plan-position alphanumeric displays. Associated with each extrapolated flight plan in the system will be a display message containing aircraft identity and appropriate control information, such as, altitude occupied, conflict status, etc. Each track in the system will have a similar message associated with it, and selected beacon code returns processed by the system will be displayed with an associated display message. Selected processed radar data will be displayed with appropriate symbols. In addition, supplementary alphanumeric tabular displays will be generated for the margin of the plan-position display.

3.1.1 In addition to the automatically generated displays, this function will make up, format, and tag for routing, requested output messages for the plan-position alphanumeric displays based upon requests received from the inputs processing programs. Requestable displays will consist of flight plan route, display of flights by altitude, etc.

3.1.2 Each display message will be assigned to one or more of several display categories based on status information of the flight plan, track, or radar data. These categories will, in part, determine the routing of display messages; and, in part, will be selectively available to the operator at each display as an aid to display clutter reduction.

3.2 Tabular Display Generation.- The tabular display generation function will automatically make up, format, and tag for routing, flight plan data and control order displays for control positions and air movements data summaries for planning and flow control positions. These outputs will be displayed on the tabular display elements. Tabular displays will be generated on demand when changes occur.

3.3 On-Demand Printer Outputs.- Each keyboard or pushbutton input unit will have associated with it a printer output device. Each keyboard input and a portion of the input units will generate a printed acknowledgement receipt on the appropriate printer, and will generate printer outputs determined by the nature of the input. If an input cannot be interpreted by the inputs processor, a request for additional information will be generated on the output channel, initiating a dialogue which may be terminated by the correction of the input or its cancellation. Representative output messages are:

- (a) Acknowledgement.
- (b) Further information request.
- (c) Stored flight plan route/time information.
- (d) Detailed conflict information on a flight plan.

3.4 Automatic Printer Outputs.- Periodically, various status printouts will be generated automatically and routed to high-speed printer output devices. The automatic printouts will consist mainly of flight plan information which may be used for back-up during periods of tabular display failure.

3.5 Inter-facility Outputs.- Air movements and transfer of control data will be automatically crosstold between adjacent centers. This function will make up, format, and tag for routing, these inter-facility output messages. Representative examples of these inter-facility output messages are:

- (a) Air Movement Data
 - (1) Flight Plans
 - (2) Flight Plan Modifications
 - (3) Progress Reports
 - (4) Track Data

- (b) Transfer of Control Data
 - (1) Prepare Handover
 - (2) Accept Handover
 - (3) Assume Control

4. Executive Control Processing Area.- This section describes those functions necessary for control fo the data-processing functions.

4.1 Operate Mode Control.- Operate mode control will, upon starting or restarting the computing complex, determine in which of the specified modes the complex shall operate. This determination will be based on a preplanned order or manual instruction. When initiating the processing cycle, the operate mode control function will properly initialize all necessary portions of the data-processing complex and transfer control to the appropriate sequence and timing control functions.

4.1.1 When restarting, the operate mode control function will expand pertinent safe data into a complete data base appropriate to the current mode of operation.

4.2 Sequence and Timing Control.- Sequence and timing controls the sequence and frequency of operation for all enroute data processing functions. Sequence and timing also controls the input and output of

data between external devices and the computing complex, and assures that internal transfers of programs and tables are executed in a timely manner. In addition, this function controls the recording of safe data and control data.

4.2.1 Safe Data Recording.- All current air movement data must be recoverable in the event of a computer malfunction or mode change. To provide for this recovery, all information necessary to reconstruct current air movements will be periodically transferred to a storage unit which is not accessed by normal program operation and whose contents are unaffected by computer malfunction, and environmental transients such as power surges, disruptions, and the like. This storage unit is referred to as safe storage, and the information which it contains is known as safe storage. Safe storage will minimally contain that portion of track and flight movement data which will serve to reconstruct all such data. Specifically, safe data will provide for the regeneration of:

- (a) All flight plans
- (b) All prefiled routes
- (c) All wind information
- (d) All track data
- (e) All area responsibility information
- (f) All conflict information
- (g) All other essential control information
- (h) All plan-position and tabular displays

4.2.2 Control Data Recording.- Control data recording encompasses the retrieval of information during the operation of the system for subsequent (off-line) processing of the information into the written medium. The uses of control data recording vary from program shakedown to system analysis and performance monitoring. When the system is employed in the field, the recording function will also be utilized as a legal record and to recreate operational problems for detailed analysis.

4.2.2.1 The control data recording function will retrieve information from specified sections of primary memory at specified times during each system cycle, will pack and store the data in a working area, and transfer the data to tape. The control data recording function will operate with semi-permanent control table set up at the last start of the computing system.

4.2.2.2 Off-line reduction of the data will be independent of the functioning of the real-time system.

4.3 Equipment Error Detection and Recovery.- The equipment error detection and recovery function will monitor various equipment elements

of the computing complex. If it detects an error, it will attempt to recover from the error. If unsuccessful, an attempt will be made to diagnose the cause of the error, with control transferred to the mode control function. The nature of the error and the result of the recovery attempt will be printed on the on-line printer.

*Facil
safe*

4.4. Program Diagnostics.- The program diagnostic function will determine all available details about any program execution errors that occur during the real-time operation of the computing complex. The compiled information shall be printed on the on-line printer. The diagnostic function may be initialized to automatically transfer control to the mode control function upon recognizing a program malfunction.

done

4.5 Confidence Routines.- These routines will perform confidence checks during live-cycle operation in order to control the quality of computing complex operation. The results of confidence checks shall be printed on the on-line printer.

in RSPRO

5. 100- and 200-Aircraft Configurations.- The 100- and 200-aircraft configurations represent a system design that comprises a reduced functional capability, i.e., not all the functions described in the foregoing sections are performed.

5.1 200-Aircraft Configuration.- The 200-aircraft configuration has the following functional capability. Except where indicated, the functions have the capability described earlier in this appendix.

(a) Flight Plan Data Processing

- (1) Alphanumeric Inputs
- (2) Fix Time Determination

(b) Surveillance Data Processing

- (1) Controller Inputs
- (2) Radar Inputs
- (3) Automatic Tracking

(c) Output Data Processing

- (1) Plan-Position Display Generation
- (2) Flight Strip Printing--This function causes flight strips to be printed for all new flight plans and modified flight plans. This function also updates the appropriate device used to communicate changes of time and altitude data to the controller.
- (3) On-Demand Printer
- (4) Inter-Facility Outputs

5.2 100-Aircraft Configuration.- The 100-aircraft configuration has the capability to track and maintain appropriate displays for 100 flights. The functions included in this configuration are:

(a) Input and Surveillance Data Processing

- (1) Controller Inputs
- (2) Radar Inputs
- (3) Automatic Tracking

(b) Output Data Processing

- (1) Plan-Position Display Generation
- (2) On-Demand Printer
- (3) Inter-Facility Outputs

APPENDIX FTECHNICAL PROPOSAL FORMAT AND CONTENT

1. General.- The written proposals submitted in response to this RFP will be evaluated and a selection will be made which is found to be the most beneficial from the standpoints of the technical aspects, cost, and other factors such as the bidder's experience background and management considerations. However, most emphasis will be placed on the technical aspects of the proposal. Therefore, it is important that all of these points be covered adequately in the areas discussed in the following paragraphs. To permit a thorough and effective evaluation, the proposal should be precise and complete while as brief as possible. Inclusion of any important considerations not covered by this request is encouraged.

1.1 Proposal Outline.- Each of the items set forth below should be covered in the order given, with any additional items covered following as separate parts. The suggested contents within each item are not meant to be restrictive. However, the importance of furnishing, as a minimum, the specific information suggested herein cannot be overstressed, since the evaluation will depend heavily on the written proposals in selecting the successful bidder. The proposal format and contents are specified in a manner to enhance the proposal evaluation effort. Therefore, there is an intended redundancy in the requirements to specify certain items of information in various levels of detail in different sections of the proposal.

2. Hardware Considerations.- The specification permits extensive freedom in the manner in which the data processing tasks of air traffic control are organized. The data processing functions and reliability requirements have been emphasized. Only some minimum equipment requirements are stated. This approach is intended to allow the bidder freedom to propose a data processing organization and configuration of equipment for the CCC which makes optimum use of his equipment. The specification permits the use of two (but no more than two) data-processing machine types in the total of three required flight configurations (section 3.2.1.3) provided that programing is identical for each machine type and expandability requirements (3.2.1.6) are met. If the use of two machine types is proposed, the substantiative data required throughout this appendix should be furnished for each machine type separately, and, where applicable, for the system as a whole.

2.1 Overall Functional Organization.- Provide a sufficiently detailed description of the over-all functional organization of each proposed Central Computing Complex to demonstrate clearly an understanding of the data processing and reliability requirements, and capabilities of the equipment functional organization to satisfy these requirements. Present a clear explanation of how you plan to accomplish the proposed CCC design in order

to comply with the technical requirements. The details of the manner in which the experimental system was organized, although they appear in the specification, are not to be construed as restricting the bidder's proposed design beyond the stated loading information that it supplies.

2.1.1 Indicate broadly the over-all technical approach to functional organization and capability.

2.1.2 Include and/or reference pertinent sketches, drawings, charts, diagrams, etc.

2.1.3 If appropriate, indicate design alternatives which were considered and indicate the reasons for the selected design.

2.1.4 Describe the degree to which the proposed complex of equipment is off-the-shelf, and the amount of development effort required to modify existing equipment to meet the technical requirements.

2.1.5 Define the problems expected to be encountered, and the proposed methods to be used to solve the technical problems.

2.2 Executive Control (Functional Design)

2.2.1 Mode of Operation Control.- Define and describe in detail your concept of mode of operation control as it relates to the proposed CCC. In particular you shall cover but not be restricted to the following items:

- (a) The features provided to meet the data processing and reliability requirements in the A1 and C1 operating modes for the 325, 200, and 100 flight configurations. (It is recognized that the 100 flight configuration may have only the A1 mode.)
- (b) The method and time required for dynamic changeover from one mode of operation to another as a result of equipment failure or change in operating capacity requirements.
- (c) Give a general indication of what provisions could be made for functional degradation within a specified operating mode as a result of partial failure of the CCC.

2.2.2 Performance Monitoring.- Discuss a possible design which makes use of the proposed equipment complex, on-line maintenance program techniques, and the executive program to detect and diagnose failures in the real-time operation.

2.2.3 Interrupt Capability.- Describe what use the executive control function design might make of available program and/or equipment-generated interrupt capabilities in a particular CCC configuration for the A1 and C1 modes of operation.

2.2.4 Sequence and Timing.- Describe how the executive control program could insure the proper sequence of program operation when sequence is critical, how non-sequence-critical functions could be handled and what provisions are made to insure that the system will keep up in real time. Summarize the running times of all program and data transfers that are required to perform the data processing function in the A1 and C1 (A1 only for the 100-flight configuration) modes of operation for each proposed CCC. Care should be taken to assure that:

- (a) Data needed in primary storage is available when each program is operated;
- (b) Input transfers do not interfere with on-going operations; and
- (c) Output transfers are not initiated before the data is prepared.

2.2.5 CCC Size Variations.- Discuss the executive control function in terms of applicability to the three system sizes called for in this specification and expansion requirements that may occur in field installations. To what extent may reprogramming be required to handle growth, and changing functional and operational requirements?

2.2.6 Gross Flow Chart.- Provide a gross flow chart outlining your thoughts on the executive control function. Show differences, if any, between modes A1 and C1. Also, show any envisioned variations necessary for the 325, 200 and 100 flight configurations.

2.3 Central Computing Capacity.- This section describes the manner in which the bidder is asked to validate the adequacy of each proposed CCC with regard to storage, input/output, computing speed, and cycle time. Data should be presented in the format of the Primary Storage, Input/Output Transfers, and Timing tables and should be plainly identified according to which configuration--325, 200, or 100 aircraft--is intended. The functions should be listed in the execution sequence of the assumed executive control function design. If functions are executed in parallel, appropriate table format adjustments or notations should be made to clarify the presentation. Presentation of data in these tables should be keyed with a flow chart of the assumed executive control function design, and with charts showing the dynamic allocation of primary and bulk storage and timing or I/O transfers during the average processing cycle. Reasonable alternate approaches of data presentation are acceptable. However, the burden of sufficiency of proof and applicability to the problem rests with the bidder.

2.3.1 Adjustment Factors.- Appendices B, C, and D provide detailed data on the storage and computing time requirements for each of the required data processing functions. These data are expressed in terms of the program length, table lengths, and computing time required in the computer of the experimental system. The bidder is asked to scale this data in accordance with the characteristics of his proposed CCC organization. The program length for each function should be determined by adjusting the stated program length for the experimental system using the appropriate

program length adjustment factor (PLAF). The table storage requirements are stated in terms of 32-bit words and should be scaled using the appropriate data word length adjustment factor (DLAF). The computing time for each function should be determined by adjusting the stated computing time requirement for the computer of the experimental system using the appropriate computing time adjustment factor (CTAF).

2.3.1.1 Sample Problems.- Appendix A contains the specifications for sample problems that are typical of the data processing tasks encountered in air traffic control. The program length and operating time for the sample problems on the computer of the experimental system are stated. Instructions are given in Appendix A for the determination of the adjustment factors (PLAF, DLAF, and CTAF) mentioned above.

2.3.2 Storage.- Using the non-parallel processing PLAF, determine the program length for each function which you propose to execute with a single computing element. Using the parallel processing PLAF, determine the program length for each function which you propose to execute with simultaneous operation of more than one computing element. Using the format of the Primary Storage Chart in Appendices B, C, and D, present data for program length, data table storage, working table storage, peripheral data storage, estimated executive control program length, next function environment, if applicable, and bulk storage for each of the data processing functions consistent with your choice for the dynamic use of primary and bulk memory and the execution of functions for the assumed control function design. All table lengths for data storage should be obtained by adjusting the lengths specified in the Tables of B, C, and D, by the DLAF. Estimate the amount and type of bulk storage that the assumed executive control function design requires. Include in this estimate the storage necessary to effect the reliability, mode-of-operation control, and safe data requirements. In addition to the above data, provide a primary and bulk storage allocation chart showing the dynamic use of this storage and identifying transfers between these storage elements during the processing cycle consistent with the assumed executive control function design.

2.3.3 Input/Output Transfers.- Present data in the format of the Input/Output Transfer Charts of Appendices B, C, and D for all data and program transfers required to handle peripheral data, and those necessitated by the assumed executive control function design and dynamic use of primary storage. Length of each transfer should be determined by adjusting the basic data presented in the Tables of B, C, and D using the appropriate factor (PLAF or DLAF) as described in 2.3.2. This tabular listing of transfers should be keyed to the transfers identified on the primary and bulk storage allocation charts by a chart which describes the timing of all I/O transfers during the processing cycle consistent with the assumed executive control function design. Peripheral and recorded data transfers should be identified, consistent with your solution to the peripheral data handling problem.

2.3.4 Timing Data.- Present timing data in the format of the Timing Data Chart of Appendices B, C, and D for all data processing functions. The primary use of this chart will be to determine that the proposed CCC and executive control function design can perform the required functions within the specified cycle time of 2.5 seconds.

2.3.4.1 For those data processing functions which you propose to execute with a single computing element, apply the non-parallel processing CTAF (calculated for the sample problem as specified in Appendix A) to the listed computing time per cycle. For those data processing functions which you propose to execute by simultaneous operation of more than one computing element, apply the parallel processing CTAF (determined as specified in Appendix A) to the listed computing time per cycle. It may be assumed that all of the listed functions are structured in a way similar to the composite sample problem specified in Appendix A.

2.3.4.2 The estimated total transfer time (including average time spent in accessing bulk storage and peripheral data) associated with the execution of each function should be stated. This transfer time shall be estimated from the number and length of transfers necessitated by the assumed organization of the over-all data processing task and the stated characteristics of input/output channels, primary and bulk storage, peripheral data storage, and recorded data storage. Consistent with the charts describing dynamic allocation of primary and bulk storage, and timing of transfers within the processing cycle, the amount of unoverlapped transfer time associated with each function shall be determined. The unoverlapped transfer-time data is to include estimates for the effect of "break-in" memory cycles.

2.3.4.3 In addition, an estimate of the computing time allocated to each function for executive control should be entered on the timing data charts.

2.3.4.4 The operating time allocated to each function for each cycle should be computed (and entered in a blank column of the timing data charts, to be labeled "operating time") by adding the entries for computing time per cycle, unoverlapped transfer time per cycle, and executive control function time per cycle.

2.3.4.5 The total real operating time per cycle for all functions shall be computed (and stated on the timing data charts with appropriate label) by combining the individual function operating times consistent with the execution sequence of functions for the assumed executive control function design. If the functions are executed in a sequence with no overlap, the total real operating time per cycle will be the sum of the function operating times.

2.3.4.6 If your executive design proposes simultaneous execution of different functions in separate computing elements (i.e., in parallel), the total real operating time per cycle should be computed as follows: Increases, as necessary, the individual function operating time for any functions which are executed in parallel to account for simultaneous attempts by these functions to access shared memory (see appendix A, 2.2(b)).

Compute the total real operating time by subtracting the total overlapped operating time from the sum of the adjusted function operating times. This total real operating time per cycle will determine compliance with the 2.5 second cycle time requirements.

2.3.4.7 Using the charts identified in 2.3.2, 2.3.3, and 2.3.4, and a flow chart for the executive control function as you visualize it, show how each of your proposed CCC's perform the enroute functions and meet the cycle time requirement of 2.5 seconds.

2.3.5 Expandability.- State the limiting factors for expandability of the proposed CCC with regard to input/output and storage capability. If effective computing speed of the proposed CCC can be further increased, the method shall be outlined. A reasonable upper limit of effective computing speed shall then be identified. Indicate for each proposed CCC configuration by what percentage the maximum aircraft load may be increased without the addition of any other hardware. By what percentage can the maximum aircraft load of the 325-flight configuration be expanded by use of maximum permissible number of elements? The nature of time, effort, and reprogramming that may be required should be specified for each of the expandability alternatives that are described.

2.3.6 Interrupt Capability.- Describe the interrupt capabilities of your proposed equipment complex. Show how internal and external interrupts may be used in conjunction with your envisioned executive program to handle controller and peripheral device requests for service.

2.3.7 Real-Time Clocks.- Provide information as to real-time clocks that are applicable for utilization in your proposed CCC. Provide information such as:

- (a) Types (internal/external);
- (b) Interrupt features;
- (c) Computer program access and manipulation; and
- (d) Precision.

2.3.8 Code Standardization.- The adoption of American Standard Code for Information Interchange or ASA Standard No. X3.4 presages its use for filing flight plans with ATC facilities. This code is also under consideration by FAA for inter-facility transmissions, with its adoption probable. Furthermore, certain plan-position displays being procured by FAA have alphanumeric inputs that use the 6-bit subset of the X3.4 code containing the alphanumeric characters, and it is desired to continue this practice. Describe how you would adapt the CCC to the above uses. Indicate what effects this would have on system-oriented and computer-oriented peripheral devices.

2.4 Reliability Design

2.4.1 Reliability requirements have been imposed on the entire Central Computing Complex. Therefore, the development of the reliability design should give consideration to the following factors.

Discuss:

- (a) The basic elements reliabilities;
- (b) The reliability of the interconnection network(s);
- (c) The reliability of proposed peripheral-device adapter(s);
- (d) The reliability of the reconfiguration approach including
 - (1) The availability of safe-data regardless of which element fails; and
 - (2) The availability of the executive control features required for mode-of-operation control and reconfiguration of active and redundant elements.

2.4.2 The following information should be provided as a minimum. Additional information may be provided as appropriate. The definitions for the terms used in this section are presented in the specification.

- (a) Indicate the MDT (mean down time) and MUT (mean up time) of each equipment element of the CCC (computing, storage, peripheral-device adapters, etc.).
- (b) Indicate the MDT and MUT of operation--of the 325 and 200 flight configuration for both modes A1 (80-100 percent of peak demand and full functional capability) and C1 (0-50 percent of peak traffic demand and full functional capability),--and the A1 mode of operation for the 100 flight configuration.
- (c) Indicate the MDT and MUT of each CCC configuration for A1 and C1 modes of operation with one additional (beyond that required to meet the specified reliability and minimum hardware requirements) redundant element of each type (computing, storage, peripheral-device adapter, etc.) if the system configuration allows such an expansion.
- (d) Indicate the mean time between transient failures involving the failure of an active element when a redundant element is available to replace the failed element for modes A1 and C1.
- (e) The MDT and MUT for the CCC equipment elements should be based on actual operation experience insofar as possible. State the operational experience and test results for (a) and also any that would help to confirm (b) through (d). State the evaluation procedures, including loads and continuity of exercising, computer programing, and certifications applicable to these evaluations.

- (f) Wherever data from operational experience is not available in reference to (a), (b), (c), and (d) above, provide all equations, mathematical techniques, and data used in the computations. Provide derivations of techniques used in order to justify their validity.
- (g) Present the mathematical model for reliability and maintainability of the CCC configured to operate in the A1 and C1 modes of operation except that the A1 mode only is applicable to the 100 flight configuration.
- (h) In cases where the failure of an active CCC element results in switching to redundant element, describe how changes in the CCC configuration are achieved and the amount of time required for changeover.
- (i) Present the extent to which you employ the following reliability design techniques: derating of the component piece parts, use of parts having a history of reliable operation in other systems, examination of circuit and part tolerances to insure minimization of drift-type equipment failures, and a review of packaging and production methods.

2.5 Central Computer Complex Equipment

2.5.1 CCC Elements.- List the functional units, such as storage elements, computing elements, etc., which make up each proposed CCC, indicating the number, type, and capacity of each unit required to satisfy the specified CCC capabilities.

2.5.2 Peripheral Equipments.- List and describe the computer-oriented peripheral equipments proposed for use with each central computer configuration specified above. Is any provision made for high-density, low-cost magnetic tape:

2.5.3 Modularity.- Present descriptions of the nature of modularity for each CCC element and the system as a whole, as appropriate.

2.5.4 Two Data-Processor Machine Types.- The specification permits the use of two (but no more than two) data-processing machine types in the total of three required flight configurations (3.2.1.3), provided that programing is identical for each machine type and expandability requirements (3.2.1.6) are met. In general, the use of more than one type of machine tends to cause an increase in complexity of certain areas of the system and associated support activities. Therefore, each bidder who proposes use of more than one machine type shall discuss in detail the following list of system characteristics which may be considered as trade-off items in evaluating the overall effectiveness of the particular design approach:

- (a) Added costs for logistic and personnel support activities because of the use of increased hardware variety;
- (b) Technological advantages through use of the wider choice in selecting system components;
- (c) The necessity of universally meeting the interface requirements of computer-oriented and system-oriented peripheral devices; and
- (d) The need for being able to expand a configuration in small increments to keep abreast of increasing load requirements.

2.5.5 Design and Construction.- In accordance with 3.10 of the specification, it is desirable that the equipment meet requirements of ER-D-406-010, or appropriate MIL specifications, or both. If equipment meets MIL specifications, it should be so indicated with a listing of the applicable MIL specification or specifications. For equipment that does not meet MIL specifications, a description of each deviation between the equipment and the requirements of ER-D-406-010 should be furnished.

2.6 Reliability/Maintainability.- Information on the following items should be presented; additional information may be provided as appropriate.

- (a) Maintenance Approach.- Describe the maintenance approach for the CCC and show that it will adequately support all maintenance and reliability requirements. Describe in detail how scheduled and unscheduled maintenance (3.8.2.2 of specification) would be performed on the CCC elements in a 24-hour, 7-day-per-week equipment operation. In particular, describe how a subsystem of elements might be taken off-line to perform off-line maintenance functions. Confirm that sufficient controls (keys, switches, indicators, etc.) are supplied to perform this function without interfering with the operational ATC system.
- (b) Monitoring Features.- Describe the equipment monitoring features (automatic and manual) for error checking and trouble recognition while the machine is performing the operational functions.
- (c) Diagnostic and Maintenance Features.- Describe the available features for trouble isolation and definition. Indicate whether the features operate continuously or only during downtime.
- (d) Scheduled Maintenance.- Specify the frequency and length of time recommended for scheduled maintenance of each element proposed.

- (e) Instrumentation.- List the instrumentation that is provided with each proposed CCC for maintaining and repairing it. Describe separately any special equipment which is being provided in this procurement.
- (f) Standardization.- Indicate the extent to which the proposed CCC uses military approved or military standard piece parts and techniques. The degrees of circuit standardization should also be defined and described.
- (g) Quality Control.- Describe the procedures used for maintaining quality control within your organization.
- (h) Malfunction Evaluation.- Describe normal company procedures and methods for malfunction data collection, feed-back, and analysis used during environment and acceptance tests for CCC-type systems. Indicate how such data is used in corrective actions of significant reliability and/or maintainability problems at either the equipment, unit, subunit, circuit, or part level.
- (i) Failure Analysis.- Describe procedures for conducting a failure analysis effort to determine the causes of basic failures in the CCC.
- (j) Corrective Action.- Define and describe the corrective action process employed in connection with the malfunction evaluation and failure analysis activities described above.
- (k) Long-term Evaluation.- Describe procedures and methods, if any, data for collection, analysis and feedback, and corrective action process concerned with continuing evaluation of reliability and maintainability of CCC-type systems installed in the field.
- (l) Preventive Maintenance.- Present a plan for preventive maintenance of each complete CCC.
- (m) Maintenance Personnel.- Define the number and qualifications of personnel required to maintain and repair each proposed CCC for continuous operation 24 hours per day, seven days per week. Specify, by class breakdown, the type(s) and amount of training required by maintenance personnel.
- (n) CCC Operators.- Define the number and qualifications of personnel required to operate each proposed CCC for 24 hours per day, seven days per week. Specify, by class breakdown, the type(s) and amount of training required.
- (o) Variations in Manpower Requirements.- Indicate the changes in manning specified in (m) and (n) due to the operation of the CCC in the high (A1) and low (C1) load modes specified.

- (p) Spares.- Define and describe the nature and quality of spares required to support continuous operation 24 hours per day, seven days per week, for one year, for each size CCC. The method(s) used should be consistent with the reliability prediction techniques.
- (q) Maintenance and Test Equipment.- List, and describe if necessary, the quantities and types of all general and specialized maintenance and test equipment being provided (3.8.3.4) to support each size CCC. Include a per unit (approximate or firm price) cost breakdown with this data.

2.7 Environmental Factors.- Describe all aspects of each CCC environment including but not restricted to the following items:

- (a) Ambient Temperature Range.- Define the operating and non-operating acceptable temperature ranges.
- (b) Humidity Range.- Define the operating and non-operating acceptable absolute and relative humidity ranges.
- (c) Air Conditioning.- Describe any integral air and/or liquid cooling used. Discuss air conditioning failure in terms of system reliability, including operating time after failure of any integral cooling system.
- (d) Power.- Give the system power requirements, including number of circuits, voltage(s) plus tolerance, kilowatts, frequency(ies) plus tolerance, power factor, turn-on surge currents, etc. If a motor-generator set is required for normal system operation, discuss your proposed redundancy of this equipment to meet the reliability standards of this specification.

2.8 Physical Characteristics.- Describe the physical characteristics of each CCC. The information provided should include but not be restricted to the following:

- (a) Type of packaging.
- (b) Number of physical units.
- (c) Dimensions.
- (d) Type of installation--including type of building features required, such as false floors, overhead or under-floor cable of air ducts, tie-down features, etc.
- (e) Floor space--indicate the amount of floor space required for each of the three CCC configurations.

- (f) Weight and floor loading.
- (g) Level and spectrum of audible noise produced by equipment.
- (h) Cable length limits for non-contiguous location of CCC elements and/or equipments connecting to the I/O channels.
- (i) Where applicable indicate ratio of transistor use to vacuum tubes or indicate all-transistor. Report the type of circuit components and packaging used. Describe the level at which sub-assemblies would be replaced for maintenance or repair. Describe techniques and test equipment needed to repair replaceable sub-assemblies.
- (j) Electromagnetic interference characteristics, both internally or externally generated. Indicate whether shielding is required and to what extent it is required.
- (k) Explain the grounding system, and grounding requirements for peripheral equipment.

2.9 Machine Characteristics.- With regard to your proposed equipment complex, supply information regarding the following items. Additional items may be presented if appropriate.

- (a) Define type of arithmetic used. How are negative numbers handled? Is provision for floating point arithmetic included? Is provision for double precision arithmetic included?
- (b) Describe instruction repertoire.
- (c) Describe instruction execution rate and present supporting theoretical studies and measured or calculated performance based on the sample problems.
- (d) Describe I/O rate for each channel.
- (e) Describe access time(s).
- (f) Discuss transfer time(s).
- (g) Define index capability including sequential and simultaneous operations, and indirect addressing if available.
- (h) Discuss special features including but not restricted to a definition and description of the following items:
 - (1) Real time indicator(s).

- (2) Interrupt features, indicating type (equipment or program controlled), frequency of use and priority scheme, if applicable.
- (3) Error checking and trouble recognition features. Describe parity check structure included in proposed CCC. Any additional features such as confidence check routines, complete word or character checks, or automatic error correction should be carefully evaluated in terms of cost and complexity and the evaluation presented in this section.
- (4) Parallel use--i.e., the capability to use a portion of the CCC during slack times for other functions such as data reduction, training, and computer program checkout while the remaining portion of the CCC is performing the operational function.
- (5) Peripheral tie-in--the ability to connect peripheral equipments to the CCC for certain non-operational functions, such as data reduction, maintenance, and program checkout.
- (6) Interchangeability of units.
- (7) Ease of expansion.
- (8) Ease of modification for new features or functions.
- (9) Control console features and functions.
- (10) If applicable, define the nature of possible simultaneous operations such as I/O--computing operation(s) and I/O--I/O operation(s).

3. Software

3.1 Support Programs.- Describe and discuss the following software support programs. Do not necessarily limit your discussion to, but be sure to include, the items specifically mentioned in the succeeding paragraphs. In particular, clearly indicate what software you intend to supply with this procurement that is not a mandatory software package as called for in the specification.

3.1.1 Assembler.- Include in your proposal a description of the assembler stressing any inherent special features which would minimize the programing effort described in the specification. Include in this description information as to:

- (a) Supporting data or information based on existing use of the assembler in a complex similar to the CCC.

- (b) Library routines available.
- (c) Training and programmer experience level required.
- (d) Details of assembling, including:
 - (1) Assembly program size and timing information.
 - (2) Error detection characteristics.
 - (3) Listing format and content.
 - (4) Equipment required other than that in the CCC required for assembly.
 - (5) Assembly monitoring program, if any.
- (e) Program debugging aids contained with the assembler.
- (f) Insert-and-expand, delete-and-contract features.
- (g) Special features.
- (h) Limitations.

3.1.2 High Order Language.- A high order language(s) oriented to your proposed CCC is desirable. A description of the language, if any, including special features which would minimize the extensive programming effort is requested. Include in your description:

- (a) Supporting data based on existing use of this language in a complex similar to the CCC. Indicate features or functions inherent in the language that make it applicable to program development in the CCC.
- (b) Library routines available.
- (c) Training and programmer experience level required.
- (d) Language efficiency, including estimates of additional primary and bulk data storage required as the result of object code derived through use of the language.
- (e) Details of compilation including:
 - (1) Number of passes required to obtain object code;
 - (2) Program size and timing information;
 - (3) Error detection routines;
 - (4) Listing format and content;
 - (5) Equipment other than that in the CCC required for compilation; and
 - (6) Compilation monitoring program if any.
- (f) Program integration and debugging aids.

- (g) Special features.
- (h) Availability.
- (i) Limitations.

3.1.3 Utility Programs.- Discuss the characteristics of the following utility programs which are being supplied as deliverable items in accordance with the specification (section 3.7.1):

- (a) Loaders.
- (b) Dumps.
- (c) Programing debugging aids.

You are encouraged to submit descriptions of any additional utility system programs which are available but are not a mandatory deliverable item under the specification.

3.1.4 Maintenance Programs.- Discuss the characteristics of the maintenance programs which are being supplied as deliverable items in accordance with the specification (sections 3.7.3 and 3.8). Show that the hardware configurations proposed are capable of performing the software functions (on-line and off-line maintenance) regardless of whether such software is a deliverable item under the specification. If software packages already exist to perform portions of on-line or off-line maintenance tasks, or both, include a description of such software packages with the proposal.

3.1.4.1 In particular, include in your discussion a detailed review of the following items:

- (a) A detailed description of a maintenance subsystem to maintain continuity of operation and effect system re-configuration in the CCC you propose. Include:
 - (1) A description of how you would configure the maintenance subsystem;
 - (2) A description of how you would perform operational maintenance;
 - (3) Describe how you would perform preventive maintenance;
 - (4) How you plan to reconfigure the system for equipment failures and automatic mode transition; and
 - (5) What isolation procedures are necessary when using these programs to prevent interference to the operational real-time system?

- (b) A description of programs that are available or will be available that might be employed in the maintenance sub-system.
- (c) Timing and storage estimates for those routines to be included in the operational cycle time of the CCC.
- (d) A list of programs of this type which are in use, indicating user organization(s) and nature of the effort.

3.2 Program Checkout and Testing.- Discuss the following items:

- (a) Program(s) that will be available for program checkout during the production phase. Indicate documentation that will be supplied with these items.
- (b) Features available at the control console and/or in computer-oriented peripheral equipment that can be used for program checkout.

3.3 Expandability.- Describe the nature of programing effort required when additional capacity (memory or I/O) is added to the CCC but the basic functions are unchanged. Are there advantages to be gained by a substantial reprograming effort versus using expandable addressing techniques? If so, what are they.

4. Acceptance Test.- Describe in detail your approach to developing an acceptance test procedure for the CCC. List and describe the software necessary to implement this procedure.

5. Vendor Support.- Describe the nature of vendor support available to cover items such as the following:

- (a) Programing
- (b) Maintenance
- (c) In-plant facilities for testing in-service improvements.
- (d) Existing Facilities.- Describe and list existing facilities using identical or similar equipments. Indicate the availability of these facilities to support an effort concerned with the CCC.
- (e) Personnel Training.- Indicate the availability of personnel training facilities, including text or course material to train operational and maintenance personnel.

6. Additional System Information

6.1 System Support.- Discuss the suitability of the proposed computer system configurations to simplify logistic support for a maintenance system in the areas of:

- (a) Spare parts;
- (b) Personnel training in programing and maintenance; and
- (c) Software implementation to cover initial installations and later functional additions.

6.2 Overhead Development Facility.- Discuss the suitability of the proposed CCC for use at an overhead development facility to provide for:

- (a) Standardization of hardware and software elements throughout the field;
- (b) Standardized documentation;
- (c) Maintenance of programs in the field; and
- (d) Development of software improvements and additions for inclusion in field installations.

_____ 0 _____

