



Condor-G: Globus + Condor



the globus project
www.globus.org



Condor
High Throughput Computing

- middleware deployed across entire Grid
- remote access to computational resources
- dependable, robust data transfer
- job scheduling across multiple resources
- strong fault tolerance with checkpointing and migration
- layered over Globus as "personal batch system" for the Grid

DiSCoV  September 2004 Paul A. Farrell
Grid Computing 1

Installing Condor-G

- Get Condor from the UW web site: <http://www.cs.wisc.edu/condor>
 - Condor is "included" as Globus Universe.
 - OR –
- Install from NMI: <http://www.nsf-middleware.org>
 - OR –
- Install from VDT: <http://www.griphyn.org/vdt>
- Condor-G can be installed on your own workstation, no root access required, no system administrator intervention needed

DiSCoV  September 2004 Paul A. Farrell
Grid Computing 2

Condor-G will ...

- ... keep an eye on your jobs and will keep you posted on their progress
- ... implement your policies for the execution order of your jobs
- ... keep a log of your job activities
- ... add fault tolerance to your jobs
- ... implement your policies on how your jobs respond to grid and execution failures

DiSCoV  September 2004 Paul A. Farrell
Grid Computing 3

Getting Started: Submitting Jobs to Condor-G

- Make your job "grid-ready"
- Get permission to run jobs on a grid site.
- Create a *submit description* file
- Run *condor_submit* on your submit description file

DiSCoV  September 2004 Paul A. Farrell
Grid Computing 4

Making your job grid-ready

- Must be able to run in the background: no interactive input, windows, GUI, etc.
- Can still use `STDIN`, `STDOUT`, and `STDERR` (the keyboard and the screen), but files are used for these instead of the actual devices
- Organize data files

Creating a Submit Description File

- A plain ASCII text file
- Tells Condor-G about your job:
 - Which executable, grid site, input, output and error files to use, command-line arguments, environment variables, etc.
- Can describe many jobs at once (a “cluster”) each with different input, arguments, output, etc.

Simple Submit Description File

```
# Simple condor_submit input file
# (Lines beginning with # are comments)
# NOTE: the words on the left side are not
#       case sensitive, but filenames are!
Universe      = globus
GlobusScheduler = host.domain.edu/jobmanager
Executable   = my_job
Queue
```

Running condor_submit

- You give `condor_submit` the name of the submit file you have created
- `condor_submit` parses the file, checks for errors, and creates a “ClassAd” that describes your job(s)
- Sends your job’s ClassAd(s) and executable to the Condor-G `schedd`, which stores the job in its queue
 - Atomic operation, two-phase commit
- View the queue with `condor_q`

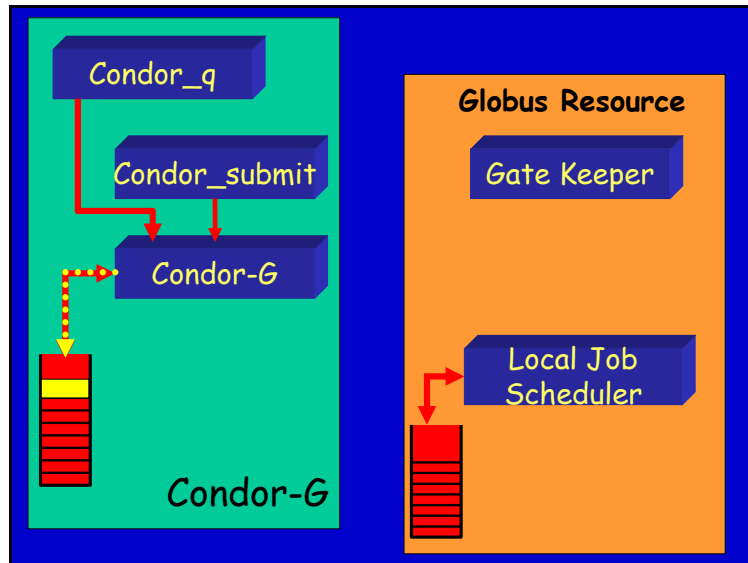

Running condor_submit

```

% condor_submit my_job.submit-file
Submitting job(s).
1 job(s) submitted to cluster 1.

% condor_q

-- Submitter: perdita.cs.wisc.edu : <128.105.165.34:1027> :
ID   OWNER      SUBMITTED   RUN_TIME ST PRI SIZE CMD
1.0  frieda     6/16 06:52  0+00:00:00 I 0  0.0 my_job

1 jobs; 1 idle, 0 running, 0 held

%
    
```

DISCoV  September 2004 Paul A. Farrell
Grid Computing 10

Another Submit Description File

```

# Example condor_submit input file
# (Lines beginning with # are comments)
# NOTE: the words on the left side are not
#       case sensitive, but filenames are!
Universe      = globus
GlobusScheduler = host.domain.edu/jobmanager
Executable   = /home/wright/condor/my_job.condor
Input        = my_job.stdin
Output       = my_job.stdout
Error        = my_job.stderr
Arguments    = -arg1 -arg2
InitialDir   = /home/wright/condor/run_1
Queue
    
```

DISCoV  September 2004 Paul A. Farrell
Grid Computing 11

Using condor_rm

- If you want to remove a job from the Condor-G queue, you use *condor_rm*
- You can only remove jobs that you own (you can't run *condor_rm* on someone else's jobs unless you are root)
- You can specify specific job ID's, or you can remove all of your jobs with the "-a" option.

DISCoV  September 2004 Paul A. Farrell
Grid Computing 12

Temporarily halt a Job

- Use `condor_hold` to place a job on hold
 - Kills job if currently running
 - Will not attempt to restart job until released
 - Sometimes Condor-G will place a job on hold itself ("system hold") due to grid problems.
- Use `condor_release` to remove a hold and permit job to be scheduled again

Using condor_history

- Once your job completes, it will no longer show up in `condor_q`
- You can use `condor_history` to view information about a completed job
- The status field ("ST") will have either a "C" for "completed", or an "X" if the job was removed with `condor_rm`

Getting Email from Condor-G

- By default, Condor-G will send you email when your jobs completes
 - With lots of information about the run
- If you don't want this email, put this in your submit file:
`notification = never`
- If you want email every time something happens to your job (failure, exit, etc), use this:
`notification = always`

Getting Email from Condor-G

- If you only want email in case of errors, use this:
`notification = error`
- By default, the email is sent to your account on the host you submitted from. If you want the email to go to a different address, use this:
`notify_user = email@address.here`

A Job's life story: The "User Log" file

- A UserLog must be specified in your submit file:
 - Log = filename
- You get a log entry for everything that happens to your job:
 - When it was submitted to Condor-G, when it was submitted to the remote Globus jobmanager, when it starts executing, completes, if there are any problems, etc.
- Very useful! Highly recommended!

Uses for the User Log

- Easily read by human or machine
 - C++ library and Perl Module for parsing UserLogs is available
- Event triggers for meta-schedulers
 - Like DAGMan...
- Visualizations of job progress
 - Condor-G JobMonitor Viewer

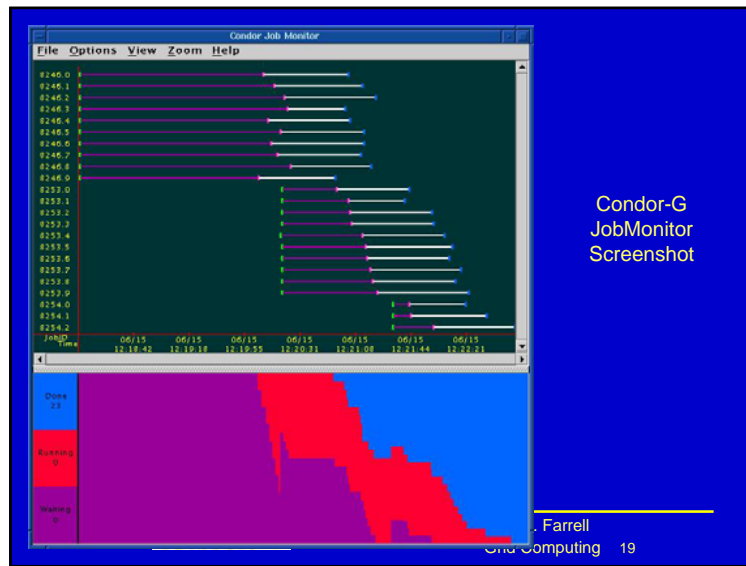

Want other Scheduling possibilities? Use the Scheduler Universe

- In addition to Globus, another job universe is the *Scheduler Universe*.
- Scheduler Universe jobs run on the submitting machine.
- Can serve as a meta-scheduler.
- DAGMan meta-scheduler included

DAGMan

- **D**irected **A**cyclic **G**raph **M**anager
- DAGMan allows you to specify the *dependencies* between your Condor-G jobs, so it can *manage* them automatically for you.
- (e.g., "Don't run job "B" until job "A" has completed successfully.")

DISCoV  September 2004 Paul A. Farrell
Grid Computing 21

What is a DAG?

- A DAG is the **data structure** used by DAGMan to represent these dependencies.
- Each job is a **"node"** in the DAG.
- Each node can have any number of "parent" or "children" nodes – as long as there are **no loops!**

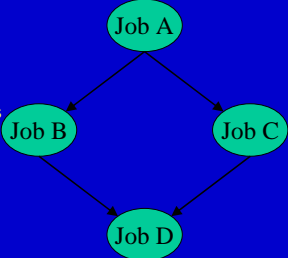

DISCoV  September 2004 Paul A. Farrell
Grid Computing 22

Defining a DAG

- A DAG is defined by a **.dag file**, listing each of its nodes and their dependencies:

```
# diamond.dag
Job A a.sub
Job B b.sub
Job C c.sub
Job D d.sub
Parent A Child B C
Parent B C Child D
```

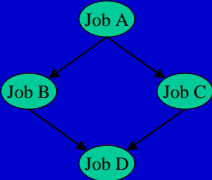

- each node will run the Condor-G job specified by its accompanying **Condor submit file**

DISCoV  September 2004 Paul A. Farrell
Grid Computing 23

Submitting a DAG

- To start your DAG, just run **condor_submit_dag** with your .dag file, and Condor will start a personal DAGMan daemon which to begin running your jobs:

```
% condor_submit_dag diamond.dag
```

- **condor_submit_dag** submits a Scheduler Universe Job with DAGMan as the executable.
- Thus the DAGMan daemon itself runs as a Condor-G scheduler universe job, so you don't have to baby-sit it.

DISCoV  September 2004 Paul A. Farrell
Grid Computing 24

Running a DAG

- DAGMan acts as a "meta-scheduler", managing the submission of your jobs to Condor-G based on the DAG dependencies.

Condor-G Job Queue (A)

DAGMan (A, B, C, D)

.dag File

DISCoV KENT STATE September 2004 Paul A. Farrell Grid Computing 25

Running a DAG (cont'd)

- DAGMan holds & submits jobs to the Condor-G queue at the appropriate times.

Condor-G Job Queue (B, C)

DAGMan (A, B, C, D)

DISCoV KENT STATE September 2004 Paul A. Farrell Grid Computing 26

Running a DAG (cont'd)

- In case of a job failure, DAGMan continues until it can no longer make progress, and then creates a "rescue" file with the current state of the DAG.

Condor-G Job Queue

DAGMan (A, B, C, D)

Rescue File

DISCoV KENT STATE September 2004 Paul A. Farrell Grid Computing 27

Recovering a DAG

- Once the failed job is ready to be re-run, the rescue file can be used to restore the prior state of the DAG.

Condor-G Job Queue (C)

DAGMan (A, B, C, D)

Rescue File

DISCoV KENT STATE September 2004 Paul A. Farrell Grid Computing 28

Recovering a DAG (cont'd)

- Once that job completes, DAGMan will continue the DAG as if the failure never happened.

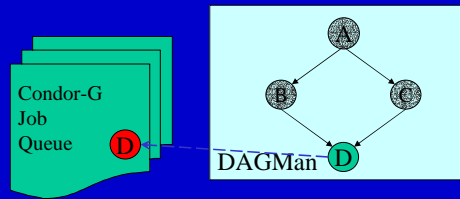

Finishing a DAG

- Once the DAG is complete, the DAGMan job itself is finished, and exits.

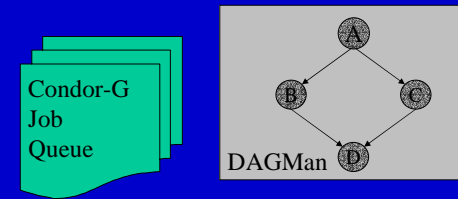

Additional DAGMan Features

- Provides other handy features for job management...
 - nodes can have **PRE** & **POST** scripts
 - failed nodes can be automatically re-tried a configurable number of times
 - job submission can be "throttled"

We've seen how Condor-G will

- ... keep an eye on your jobs and will keep you posted on their progress
- ... implement your policy on the execution order of the jobs
- ... keep a log of your job activities
- ... *add fault tolerance to your jobs ?*

condor_master

- Starts up the Condor-G daemon
- If there are any problems and the daemon exits, it restarts it and sends email to the administrator
- Checks the time stamps on the binaries of the other Condor-G daemons, and if new binaries appear, the master will gracefully shutdown the currently running version and start the new version

DISCoV



September 2004

Paul A. Farrell
Grid Computing 33

condor_master (cont'd)

- Acts as the server for many Condor-G remote administration commands:
 - *condor_reconfig, condor_restart, condor_off, condor_on, condor_config_val*, etc.

DISCoV



September 2004

Paul A. Farrell
Grid Computing 34

condor_schedd

- Represents users to the Condor-G system
- Maintains the persistent queue of jobs
- Responsible for contacting available grid sites and sending them jobs
- Services user commands which manipulate the job queue:
 - *condor_submit, condor_rm, condor_q, condor_hold, condor_release, condor_prio, ...*

DISCoV



September 2004

Paul A. Farrell
Grid Computing 35

condor_collector

- Collects information on available resources from multiple grid sites
 - “Directory Service” / Database for Condor-G
- Each site sends a periodic update called a “ClassAd” to the collector
- Services queries for information:
 - Queries from Condor-G
 - Queries from users (*condor_status*)

DISCoV



September 2004

Paul A. Farrell
Grid Computing 36

condor_negotiator

- Performs "matchmaking" for Condor-G
- Gets information from the collector about available grid resources and idle jobs, and tries to match jobs with sites
- Not an exact science due to the nature of the grid
 - Information is out of date by the time it arrives.
 - ...but good for large scale assignment of jobs to avoid idle sites or overstuffed queues.
 - ...and policy expressions can be used to "re-match" jobs to new sites if things don't turn out as expected...

Job Policy Expressions

- User can supply job policy expressions in the submit file.
- Can be used to describe a successful run.
 - `on_exit_remove = <expression>`
 - `on_exit_hold = <expression>`
 - `periodic_remove = <expression>`
 - `periodic_hold = <expression>`

Job Policy Examples

- Do not remove if exits with a signal:
`on_exit_remove = ExitBySignal == False`
- Place on hold if exits with nonzero status or ran for less than an hour:
`on_exit_hold = ((ExitBySignal==False) && (ExitSignal != 0)) || ((ServerStartTime - JobStartDate) < 3600)`
- Place on hold if job has spent more than 50% of its time suspended:
`periodic_hold = CumulativeSuspensionTime > (RemoteWallClockTime / 2.0)`

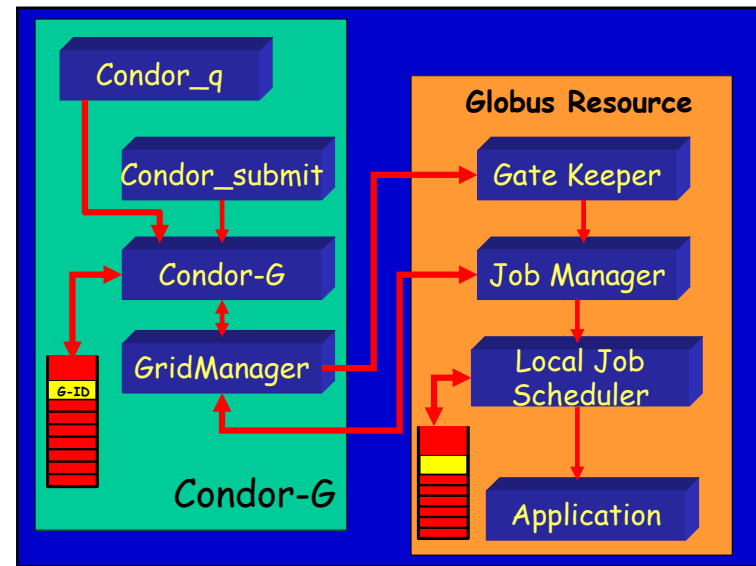

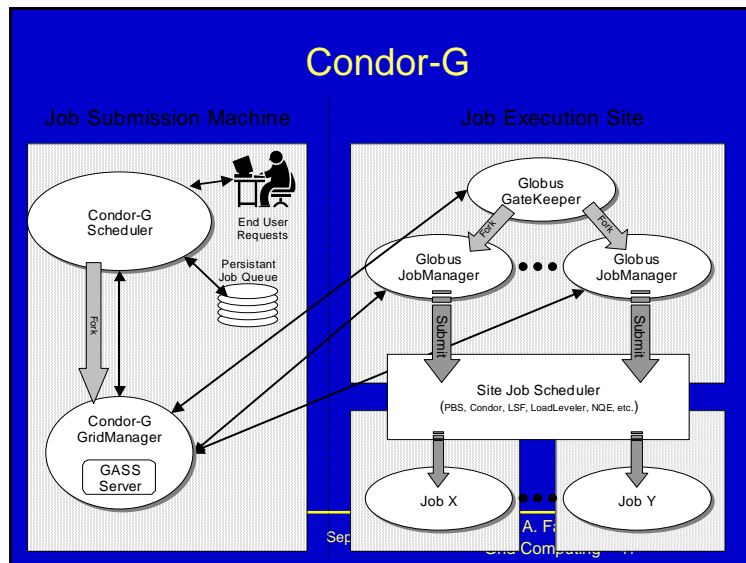

Grid Job Concerns

- What about Fault Tolerance?
 - Local Crashes
 - What if the Condor-G machine goes down?
 - Network Outages
 - What if the connection to the remote Globus jobmanager is lost?
 - Remote Crashes
 - What if the remote Globus jobmanager crashes?
 - What if the remote machine goes down?

DISCoV  September 2004 Paul A. Farrell
Grid Computing 42

Changes for Fault Tolerance

- Ability to restart a JobManager
- Enhanced two-phase commit submit protocol
- GASS cache scalability improvements
- Condor-G launches *Grid Monitor* daemons on remote sites to reduce the number of active jobmanager processes running.

DISCoV  September 2004 Paul A. Farrell
Grid Computing 43

Condor-G Fault-Tolerance: Submit-side Failures

- All relevant state for each submitted job is stored persistently in the Condor-G job queue.
- This persistent information allows the Condor-G GridManager upon restart to read the state information and reconnect to JobManagers that were running at the time of the crash.
- If a JobManager fails to respond...

DISCoV  September 2004 Paul A. Farrell
Grid Computing 44



Globus Universe Fault-Tolerance: Credential Management

- Authentication in Globus is done with limited-lifetime X509 proxies
- Proxy may expire before jobs finish executing
- Condor can put jobs on hold and email user to refresh proxy
- Todo: Interface with MyProxy...

But Frieda Wants More...

- She wants to run standard universe jobs on Globus-managed resources
 - For matchmaking and dynamic scheduling of jobs
 - Note: Condor-G will now do matchmaking!
 - For job checkpointing and migration
 - For remote system calls

Solution: Condor-G Glideln

- Frieda can use Condor-G to launch Condor daemons on Globus resources
- When the resources run these Glideln jobs, they will join a **temporary Condor Pool**
- She can then submit Condor Standard, Vanilla, PVM, or MPI Universe jobs and they will be matched and run on the Globus resources, as if they were "opportunistic" Condor resources.

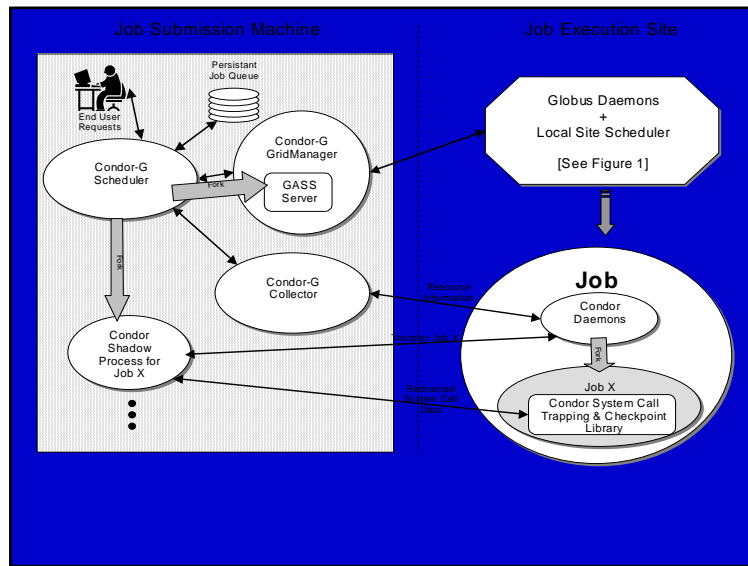
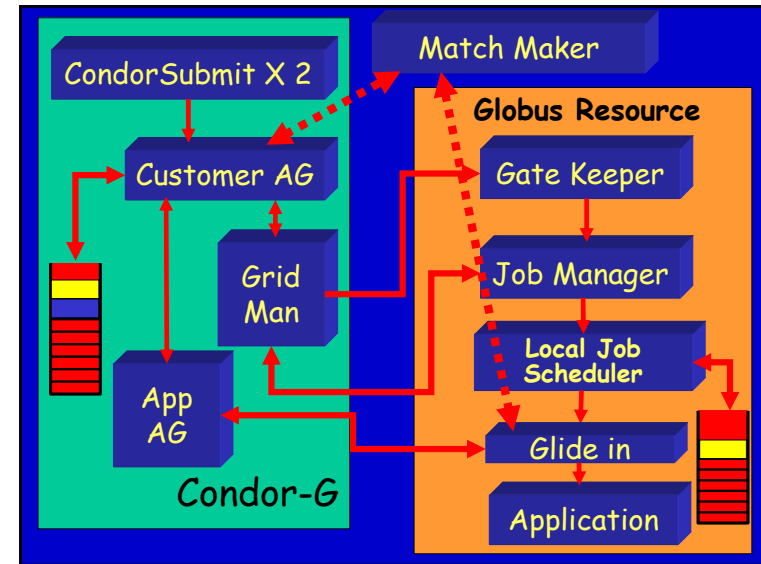
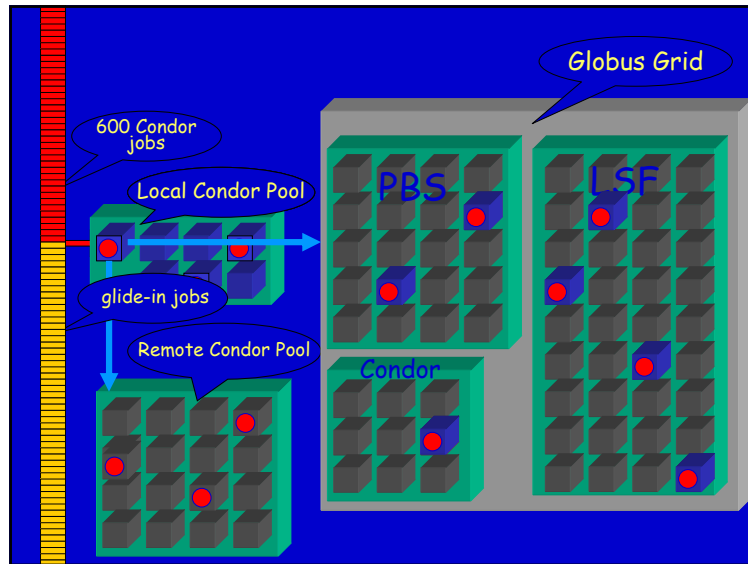

GlideIn Concerns

- What if a Globus resource kills my GlideIn job?
 - That resource will disappear from your pool and your jobs will be rescheduled on other machines
 - Standard universe jobs will resume from their last checkpoint like usual
- What if all my jobs are completed before a GlideIn job runs?
 - If a GlideIn Condor daemon is not matched with a job in 10 minutes, it terminates, freeing the resource

DiSCoV
KENT STATE
September 2004
Paul A. Farrell
Grid Computing 52

In Review

With Condor-G Frieda can...

- ... manage her compute job workload
- ... access remote compute resources on the Grid via Globus Universe jobs
- ... carve out her own personal Condor Pool from the Grid with Glideln technology

Condor-G Matchmaking

- Alternative to Glideln: Use Condor-G matchmaking with globus universe jobs
- Allows Condor-G to dynamically assign computing jobs to grid sites
- An example of *lazy planning*

Condor-G Matchmaking, cont.

- Normally a globus universe job must specify the site in the submit description file via the "globusscheduler" attribute like so:

```
Executable = foo
Universe = globus
Globusscheduler = beak.cs.wisc.edu/jobmanager-pbs
queue
```

Condor-G Matchmaking, cont.

- With matchmaking, globus universe jobs can use requirements and rank:

```
Executable = foo
Universe = globus
Globusscheduler = $$ (GatekeeperUrl)
Requirements = arch == LINUX
Rank = NumberOfNodes
Queue
```

- The \$\$ (x) syntax inserts information from the target ClassAd when a match is made.

Condor-G Matchmaking, cont.

- Where do these target ClassAds representing Globus gatekeepers come from? Several options:
 - Simple script on gatekeeper publishes an ad via `condor_advertise` command line utility (method used by D0 JIM, USCMS)
 - Program to query Globus MDS and convert information into ClassAd (method used by EDG)
 - Run HawkEye with appropriate plugins on the gatekeeper
- An explanation of Condor-G matchmaking setup see http://www.cs.wisc.edu/condor/USCMS_matchmaking.html

DISCoV



September 2004

Paul A. Farrell
Grid Computing 57

DAGMan Callouts

- Another mechanism to achieve lazy planning: DAGMan callouts
- Define `DAGMAN_HELPER_COMMAND` in `condor_config` (usually a script)
- The helper command is passed a copy of the job submit file when DAGMan is about to submit that node in the graph
- This allows changes to be made to the submit file (such as changing GlobusScheduler) at the last minute

DISCoV



September 2004

Paul A. Farrell
Grid Computing 58

Some Recent or soon to arrive Condor-G / DAGMan features

- Condor-G can submit and manage jobs not only in Condor and Globus managed grids, but also to
 - Nordugrid (<http://www.nordugrid.org>)
 - Oracle Database (using Oracle Call Interface [OCI] API)
 - UNICORE
- Dynamic DAGs

DISCoV



September 2004

Paul A. Farrell
Grid Computing 59

Some recent or soon to arrive Condor-G / DAGMan features, cont.

- MyProxy integration w/ Condor-G
 - Condor-G can renew grid credentials unattended
- Multi-Tier job submission
 - Allows jobs to be submitted from a machine which need not be always connected to the network (e.g. a laptop)
 - `condor_submit` sends job Classad and job "sandbox" to a remote `condor_schedd`
 - `condor_fetch_sandbox` used to retrieve output from remote `condor_schedd` when job completes
- SOAP Interface
- Job submission to Globus Toolkit 3 managed job service

DISCoV



September 2004

Paul A. Farrell
Grid Computing 60

Data Placement* (DaP) must be an integral part of the end-to-end solution

* Space management and
 Data transfer

DiSCoV  September 2004 Paul A. Farrell
 Grid Computing 61

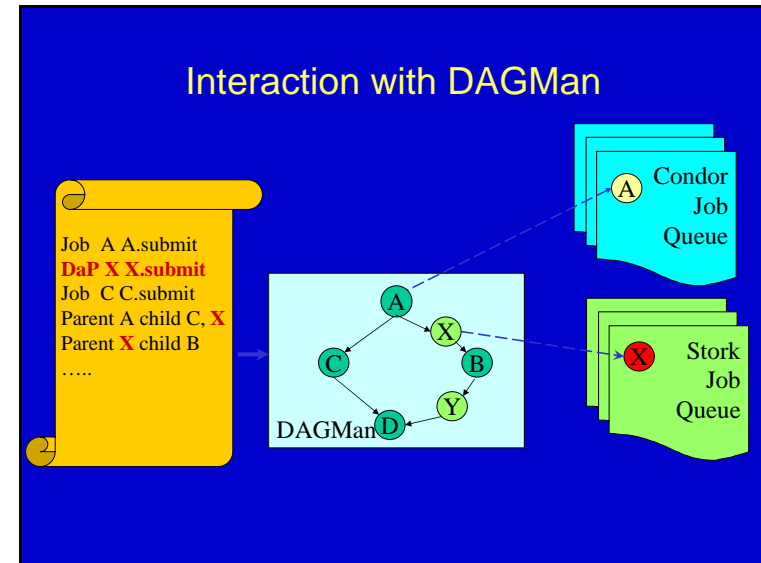

Stork

- Schedules, runs, monitors, and manages Data Placement (DaP) jobs in a heterogeneous Grid environment & ensures that they complete.
- *What Condor (G) means for computational jobs, Stork means the same for DaP jobs.*
- Just submit a bunch of DaP jobs and then relax..

DiSCoV  September 2004 Paul A. Farrell
 Grid Computing 63

